

PRECISION[®] MIS BUNION SYSTEM

SURGICAL TECHNIQUE GUIDE

Precision[®] MIS Bunion System

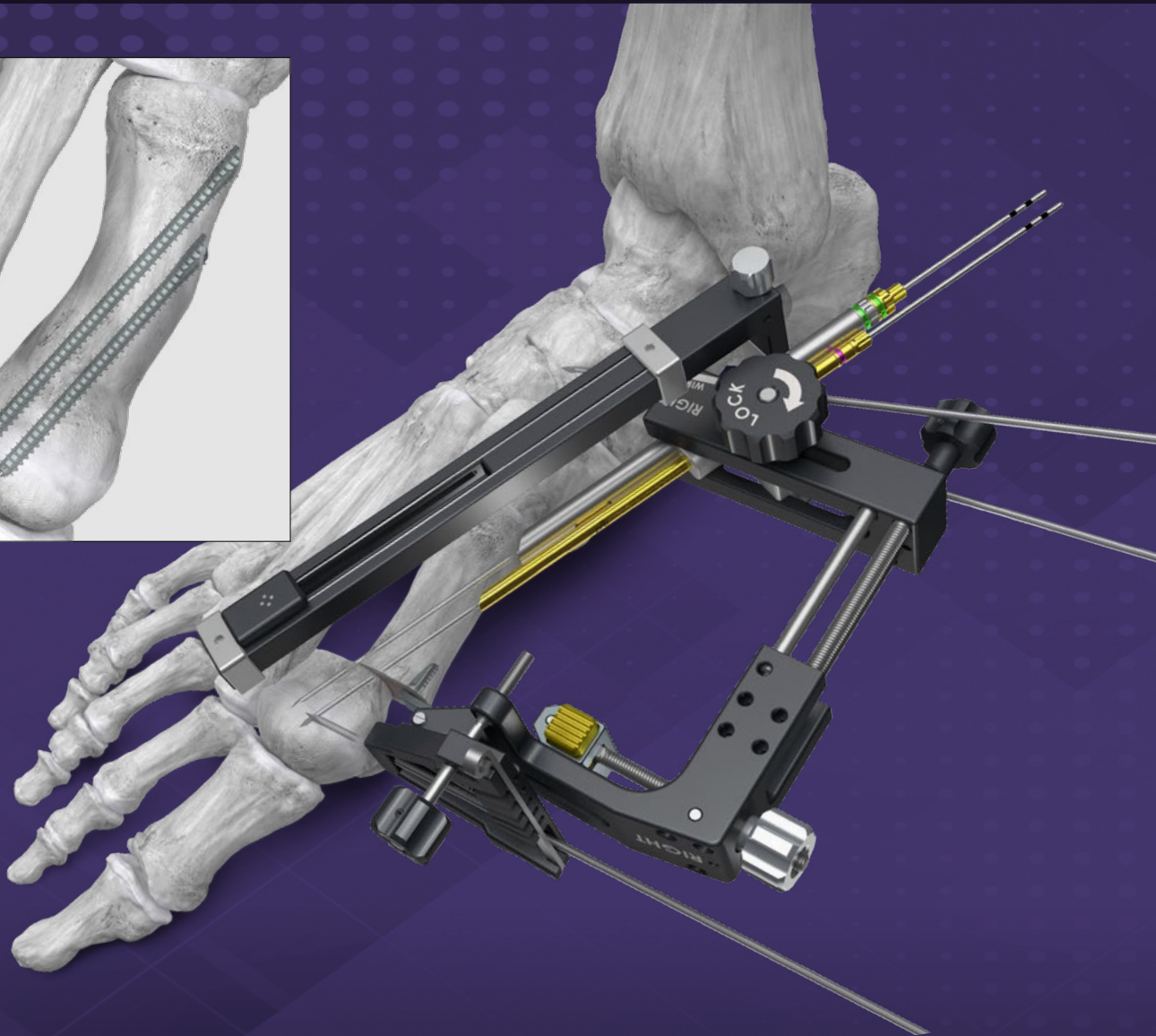

Paragon²⁰[®]

MIS Chamfer Screw System Overview

ACKNOWLEDGMENT:

Paragon 28® would like to thank David Gordon, MB ChB, MRCS, MD, FRCS (Tr & Orth); Timothy Daniels, MD, FRCS; and Mark Prissel, DPM, FACFAS for their contribution to the development of this system and technique guide.

PRODUCT DESCRIPTION

The Precision® MIS Bunion System is used to perform a distal metatarsal osteotomy by utilizing a minimally invasive surgical technique. The system includes instrumentation to complete the surgery with a guided outrigger or through a free-hand technique. The outrigger is designed to aid in the translation and derotation of the metatarsal head, and allows for control over the distal metatarsal articular angle. Correction can be established and held in place while fixation is introduced with guide wires and screws that can be targeted through the outrigger.

Cannulated chamfer screws are included within the Precision® MIS Bunion System for fixation, which allow for insertion of the screws with the head aligned with the medial cortex of the first metatarsal. This placement minimizes the prominence of the headless screws and reduces the chance of soft tissue irritation. The screws are placed over guide wires with larger diameter K-wires to help reduce the chance of unintended skiving during placement. The cannulated chamfer screws are supported with a wide range of instruments and guides to facilitate bunion correction and fixation.

CONTENTS:

SECTION 1	FEATURED INSTRUMENTATION
	FEATURED INSTRUMENTATION 3-4
	OUTRIGGER FEATURES 5
SECTION 2	SURGICAL TECHNIQUE
	INCISION AND OSTEOTOMY 6
	OUTRIGGER GUIDE ATTACHMENT 7-10
	ANGEL WING GUIDE ATTACHMENT 11
	DEFORMITY CORRECTION 12-15
	CHAMFER SCREW TARGETING 16-19
	CHAMFER SCREW INSERTION 20-24
	CLOSURE 24
	AKIN OSTEOTOMY FIXATION 25-26
SECTION 3	CADDY AND SAFETY INFORMATION
	CADDY LAYOUT 27
	CADDY CONTENTS 28-31
	INDICATIONS, CONTRAINDICATIONS, WARNINGS 32-33

FEATURED INSTRUMENTATION

	Ø3.0 mm Chamfer Screws	Ø3.5 mm Chamfer Screws	Ø4.0 mm Chamfer Screws
Screw Lengths:	Available lengths: 12 mm - 48 mm in 2 mm increments	Available lengths: 12 mm - 70 mm in 2 mm increments	Available lengths: 16 mm - 70 mm in 2 mm increments
K-wire Size:	Ø1.2 x 230 mm	Ø1.6 x 230 mm	Ø1.7 x 230 mm
K-wire Tube Size:	Ø3.0 mm	Ø3.5 mm	Ø4.0 mm
Cannulated Drill Size: (Short and Long)	Ø2.4 mm	Ø2.7 mm	Ø3.0 mm
Proximal Drill Tube Size:	Ø3.0 mm	Ø3.5 mm	Ø4.0 mm
Distal Drill Tube Size:	Ø3.0 mm	Ø3.5 mm	Ø4.0 mm
Driver Size: (Short and Long)	Ø3.0 mm	Ø3.5 mm	Ø4.0 mm



The Guide Tubes have color-coded epoxy bands to indicate their use for either the proximal (green) or distal (magenta) screw and associated hole on the barrel guide.

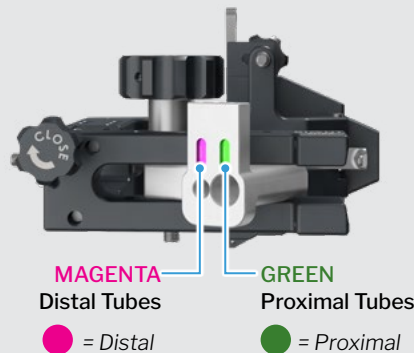

The Guide Tubes are material and text color-coded per their associated screw size for quick identification.

- Ø3.0** Ø3.0 mm screws
Black text, silver tube
- Ø3.5** Ø3.5 mm screws
Black text, gold tube
- Ø4.0** Ø4.0 mm screws
White text, dark grey tube

* 3.5mm sizes shown

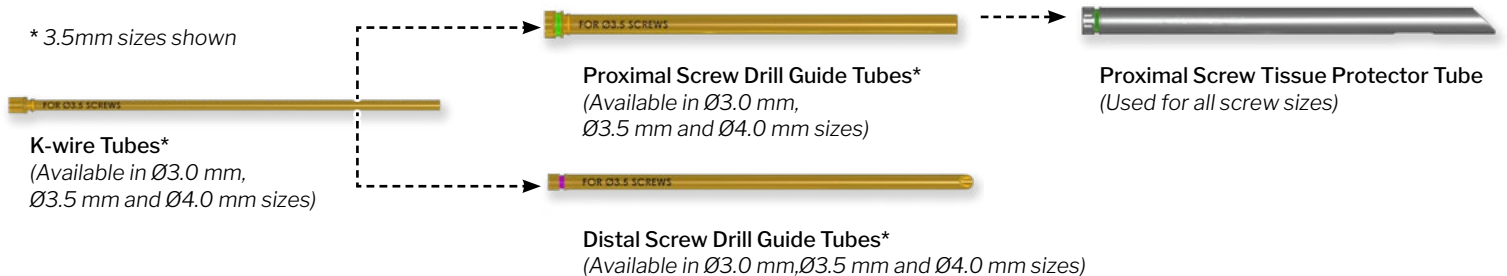

MIS Chamfer Screw System Overview

FEATURED INSTRUMENTATION



Ø2.0 mm K-wires



Screw K-wires
(Available in Ø1.2 mm, Ø1.6 mm, and Ø1.7 mm sizes for Ø3.0 mm Ø3.5 mm and Ø4.0 mm screws, respectively)



Reduction wire



Depth Gauge



Short Drill
(Available in Ø2.4 mm, Ø2.7 mm, and Ø3.0 mm sizes for Ø3.0 mm Ø3.5 mm and Ø4.0 mm screws, respectively)



Long Drill
(Available in Ø2.4 mm, Ø2.7 mm, and Ø3.0 mm sizes for Ø3.0 mm Ø3.5 mm and Ø4.0 mm screws, respectively)



Countersink
(Available in Ø3.0 mm Ø3.5 mm and Ø4.0 mm sizes)



Long Cannulated Driver
(Available in Ø3.0 mm Ø3.5 mm and Ø4.0 mm sizes)

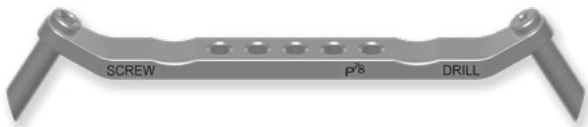

Double-Sided Drill Guide/Soft Tissue Protector
(Available in Ø3.0 mm Ø3.5 mm and Ø4.0 mm sizes)



Ø3.0 mm Parallel K-wire Guide

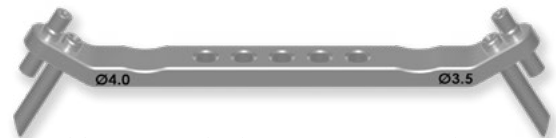

Ø3.5 mm and Ø4.0 mm Parallel K-wire Guide



Curved Elevator



Straight Elevator

OUTRIGGER FEATURES

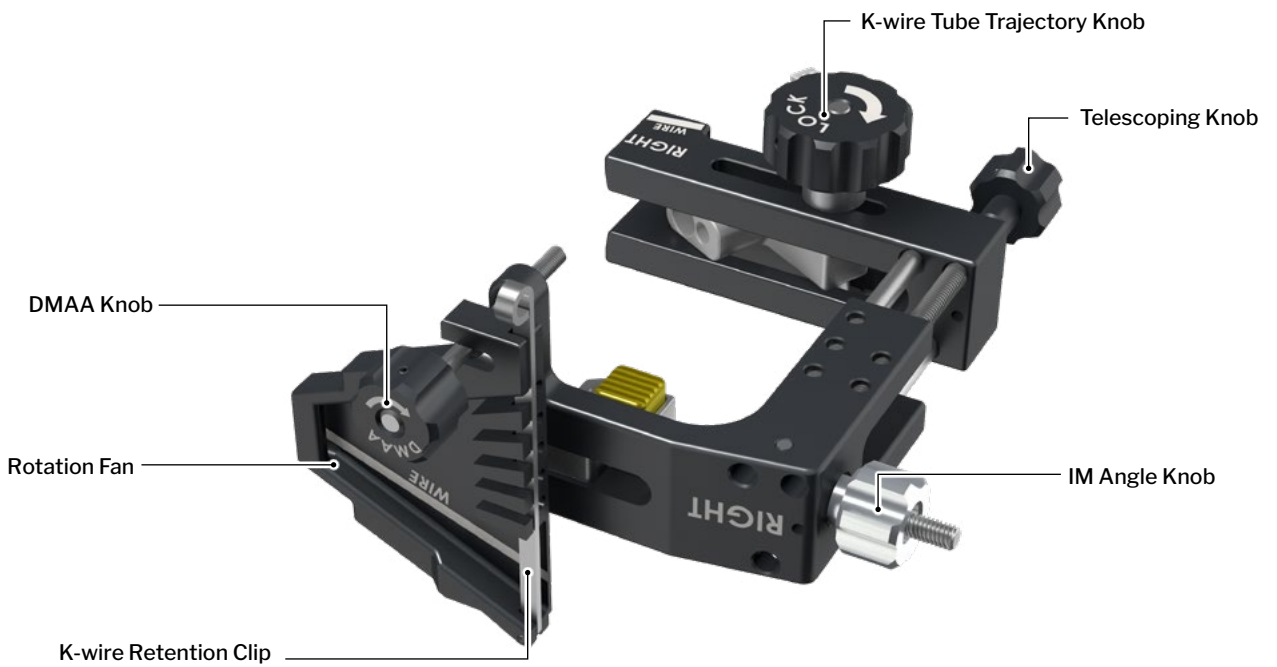
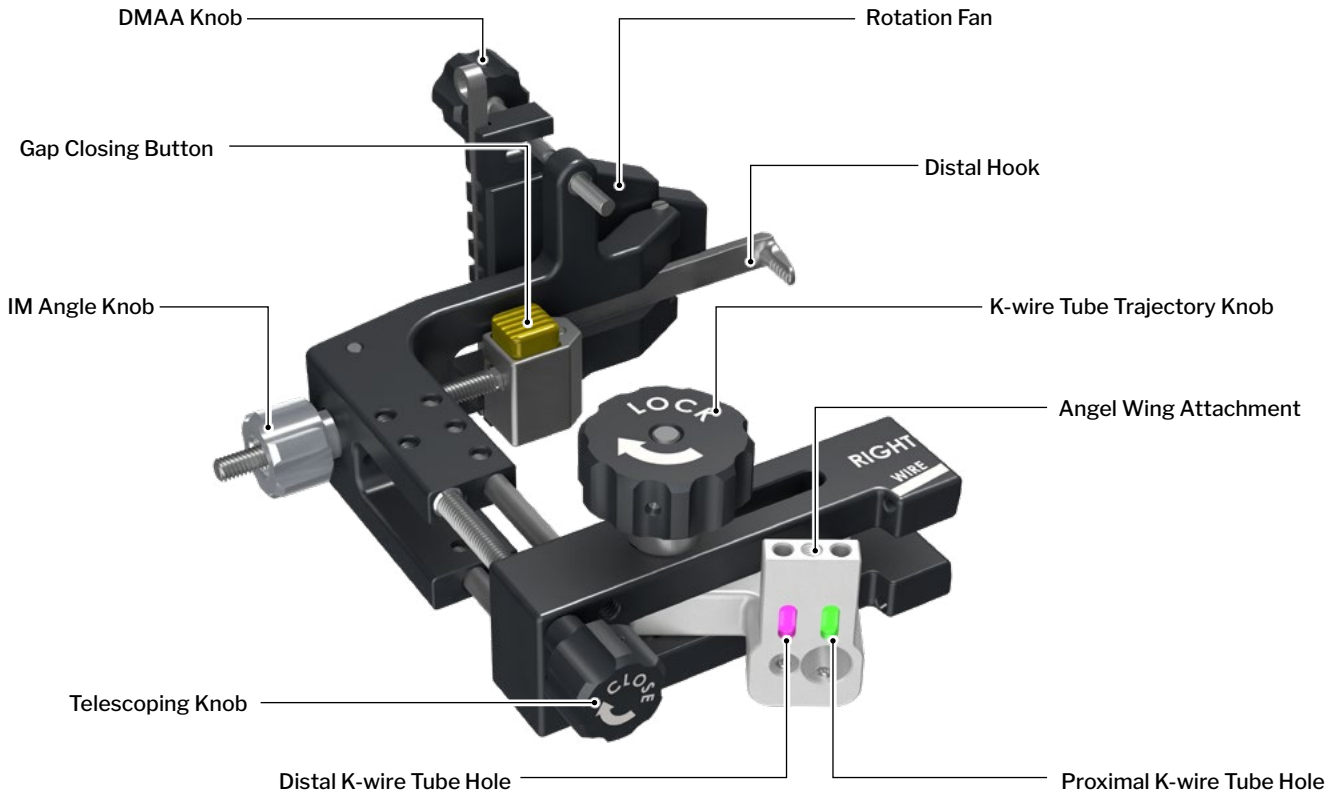

INCISION AND OSTEOTOMY

Position the patient's foot off the end of the bed to allow for dorsal-plantar and lateral fluoroscopy views of the forefoot while minimizing mini C-arm adjustment. Elevate the leg relative to the non-operative limb.

Using a freehand K-wire under fluoroscopy along with manual palpation, make a longitudinal reference line with a skin marker along the long axis of the metatarsal. As shown right, add additional markings at the first tarsometatarsal and metatarsal phalangeal joints, as well as the naviculocuneiform and talonavicular joints.

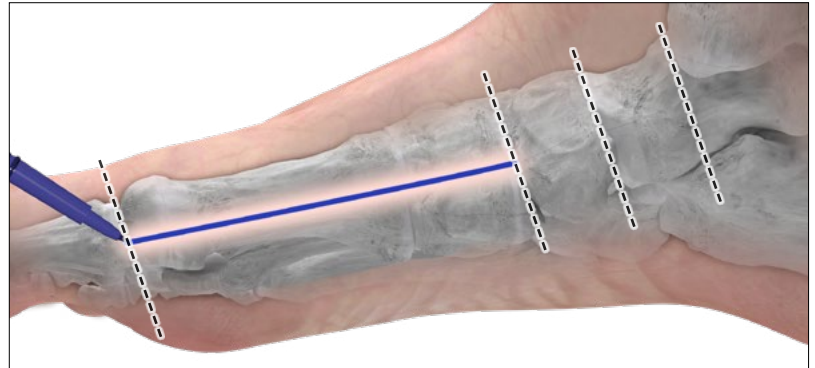

Assess and find the incision point for the osteotomy with a blunt object under fluoroscopy (e.g. a freer). The incision point should allow burr access to the neck of the 1st metatarsal. Make the incision, then insert the burr and image with fluoroscopy to confirm correct positioning.

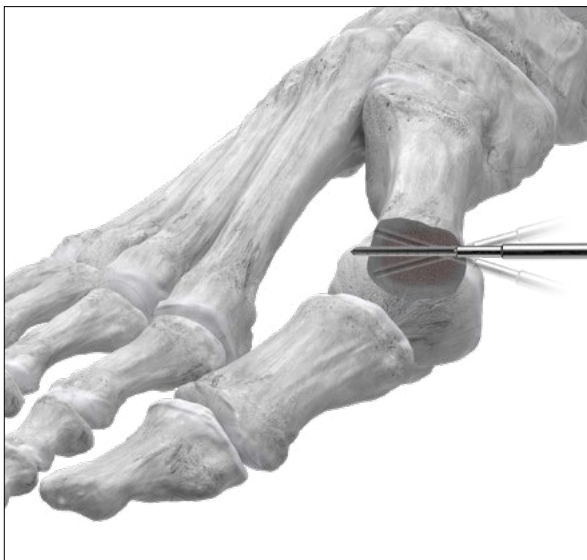
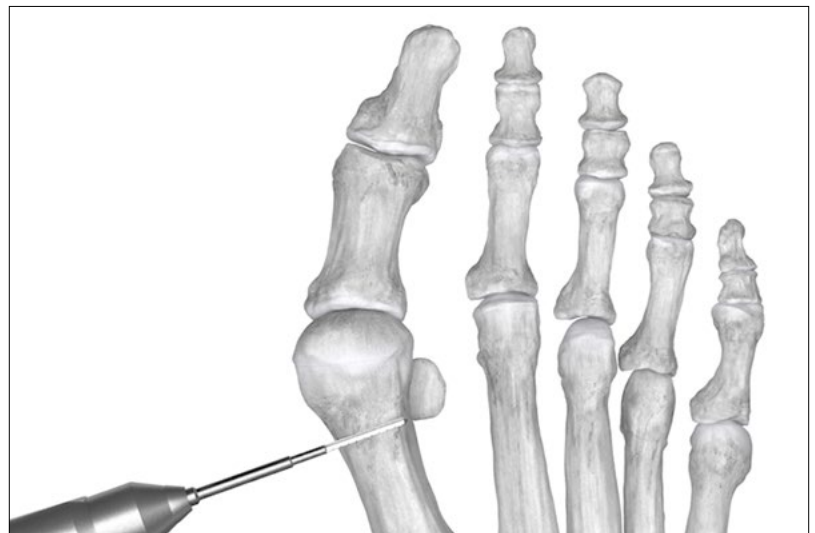

Perform the transverse burr osteotomy of the 1st metatarsal as follows: insert the powered burr through both cortices of the metatarsal, beginning slightly dorsal at the medial surface and angling plantarly to the distal surface.

Rotate the hand plantar to move the burr dorsally through the bone, then rotate the hand dorsally to move the burr plantarly to complete the osteotomy.

It is recommended to perform this osteotomy under live fluoroscopy to ensure accuracy and completion.

OUTRIGGER GUIDE ATTACHMENT

Use a freer or similar instrument to manually translate the osteotomy for access to the metatarsal intramedullary canal. Obtain the Outrigger and insert the Distal Hook through the incision and into the canal of the proximal metatarsal fragment. The IM Angle Knob can be rotated counterclockwise to extend the hook arm for easier insertion, if needed.

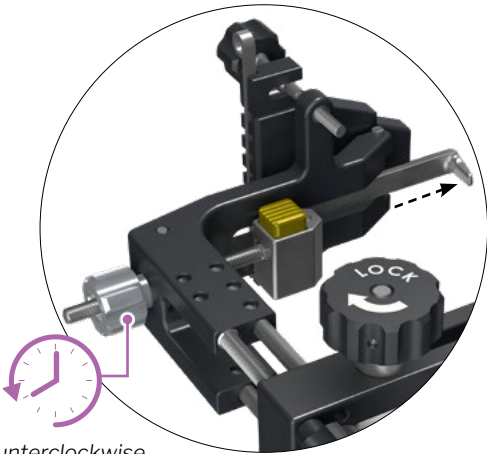

counterclockwise rotation

IM Angle Knob



Confirm appropriate hook placement in the intramedullary canal using fluoroscopy. Once confirmed, rotate the IM Angle Knob clockwise until the Rotation Fan is just touching the metatarsal head.

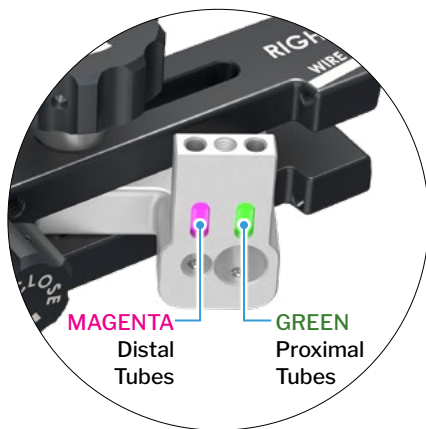

MAGENTA Distal Tubes

GREEN Proximal Tubes

Rotation Fan

clockwise rotation

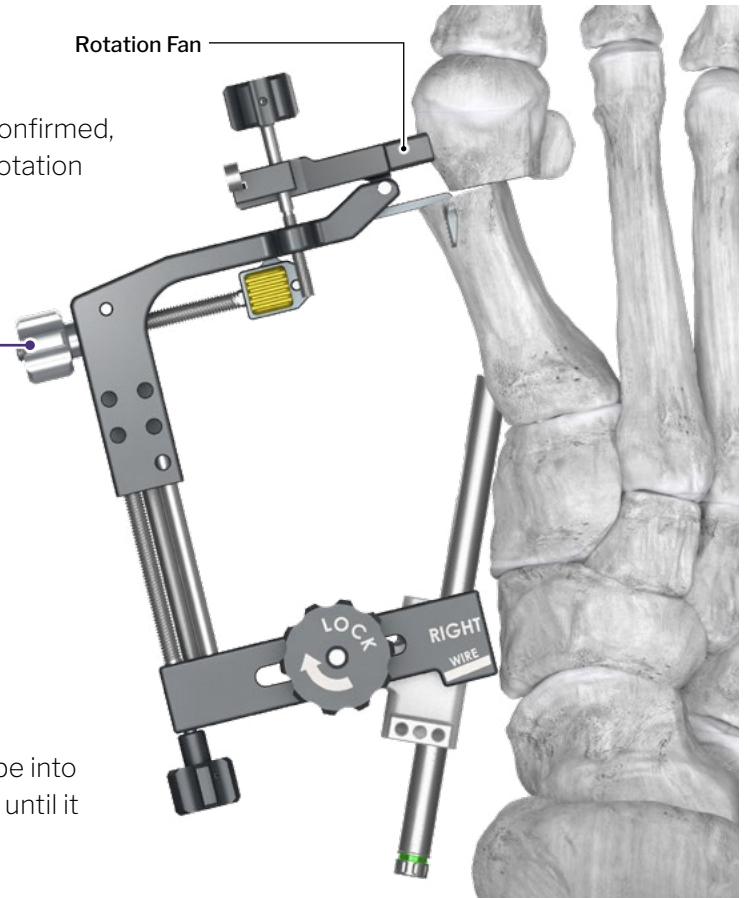

Insert the Proximal Screw Tissue Protector Tube into the Proximal K-wire Tube hole of the Outrigger until it touches the skin.

OUTRIGGER GUIDE ATTACHMENT

Under fluoroscopy, rotate the foot until a proper lateral visualization is achieved.

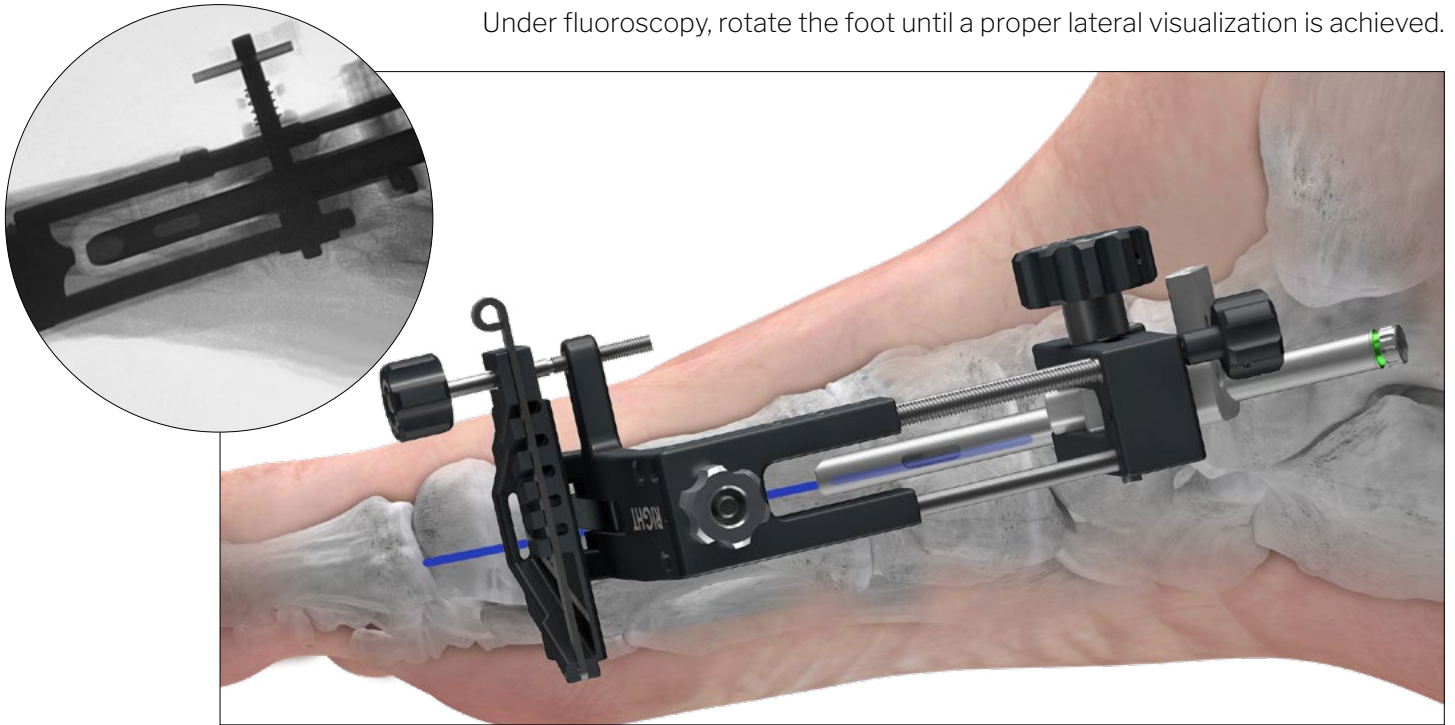

While keeping this foot position steady, rotate the outrigger in the coronal plane such that the Proximal Screw Tissue Protector Tube contacts and is aligned with the metatarsal long axis skin mark made earlier. This skin mark should also bisect the two telescoping rods of the outrigger when viewed laterally. These steps will allow for proper lateral alignment of the outrigger to the foot.

Confirm appropriate Hook placement in the canal under fluoroscopy.



TIP: A $\text{Ø}2.0$ mm K-wire can be inserted into the hole on the proximal end of the outrigger, just medial to the Telescoping Knob, to provide additional visual assistance with lateral alignment. Under fluoroscopy, when the outrigger is properly oriented laterally this wire should align the 1st metatarsal long axis precisely.



OUTRIGGER GUIDE ATTACHMENT

Align the proximal end of the Outrigger to sit between the previously marked talonavicular joint and naviculocuneiform joint, rotating the Compression Knob counterclockwise to extend the entry point proximally if needed.

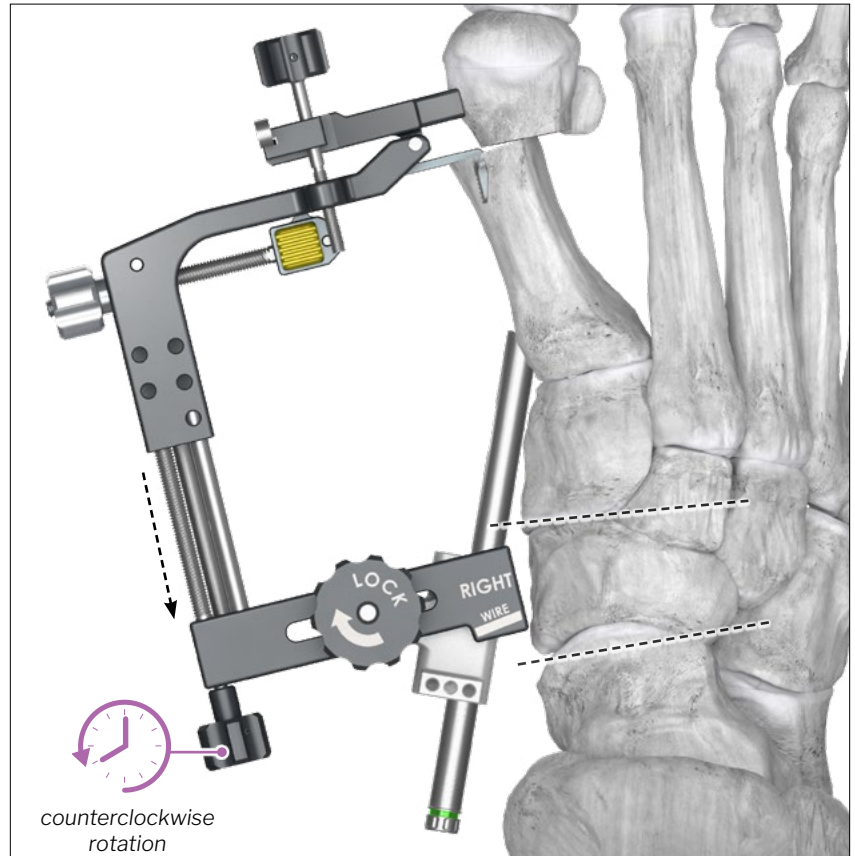

Maintaining the lateral alignment obtained previously, place one Ø2.0 mm K-wire through either of the holes on the proximal end of the Outrigger into the navicular.

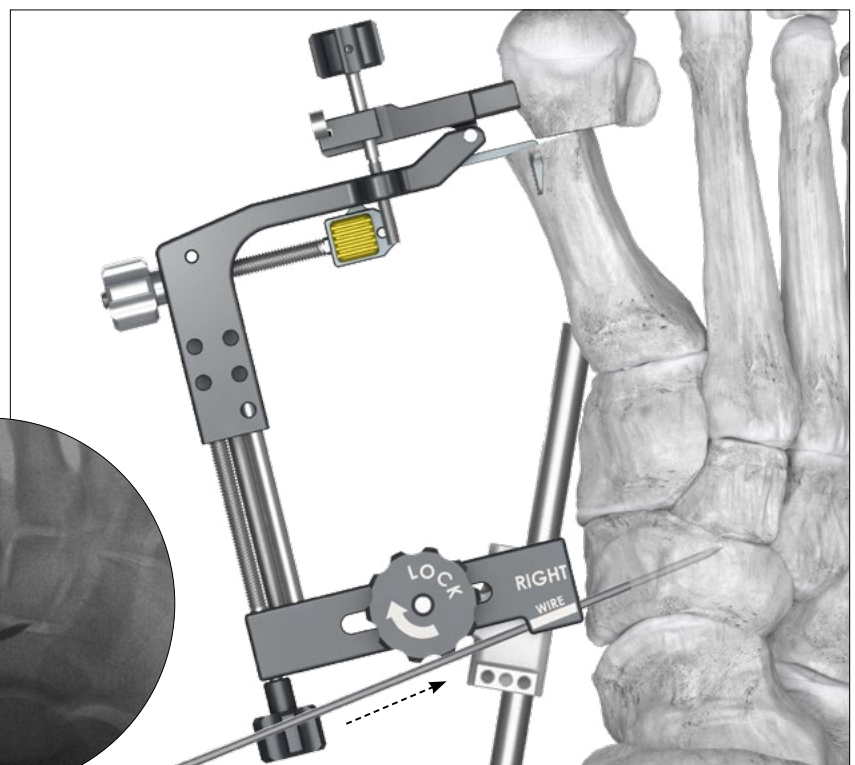

OUTRIGGER GUIDE ATTACHMENT



Swing open the K-wire Retention Clip on the Rotation Fan. Palpate the dorsal surface of the metatarsal at the osteotomy to ensure no plantarflexion or dorsiflexion occurs, then place one Ø2.0 mm K-wire along the marked line on the Rotation Fan through the hole and into the 1st metatarsal head, ending in the lateral cortex. Close the K-wire Retention Clip.

This wire should end in the lateral cortex of the metatarsal head to avoid interfering with the sesamoid.

Confirm this wire distance with dorsal-plantar fluoroscopy, and confirm that the wire is inserted centrally into the metatarsal head using lateral fluoroscopy.

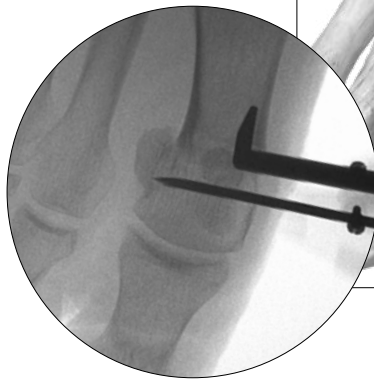

NOTE: This wire should enter the metatarsal head parallel to the osteotomy if the Rotation Fan is in its neutral position. If substantial DMAA correction will be needed, the Fan angle can be adjusted with counterclockwise turns of the DMAA Knob prior to wire placement. This adjusted trajectory will allow more room for DMAA correction later in the procedure.

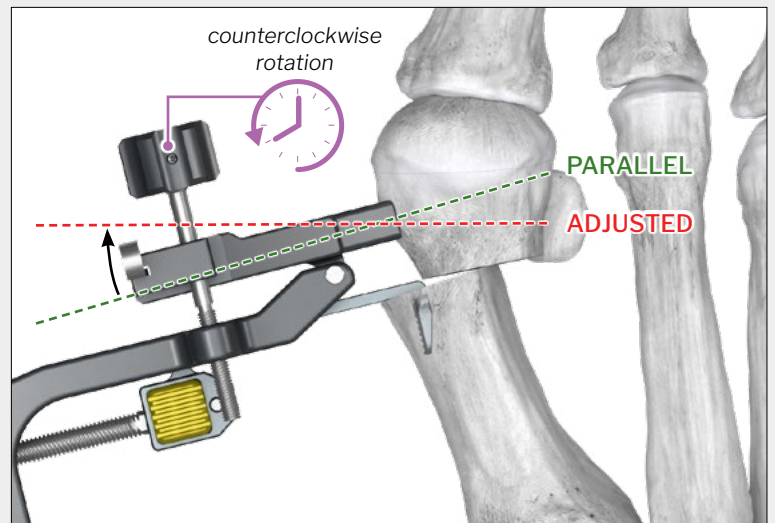

ANGEL WING ATTACHMENT

Attach the Angel Wing to the Outrigger and secure it by rotating the Turret Knob clockwise. Rotate the foot until a proper AP visualization is achieved. Keeping the foot steady in the ideal AP position, pivot the outrigger until the Angel Wing shows proper AP alignment as indicated by the “stacked” wires (see examples below).

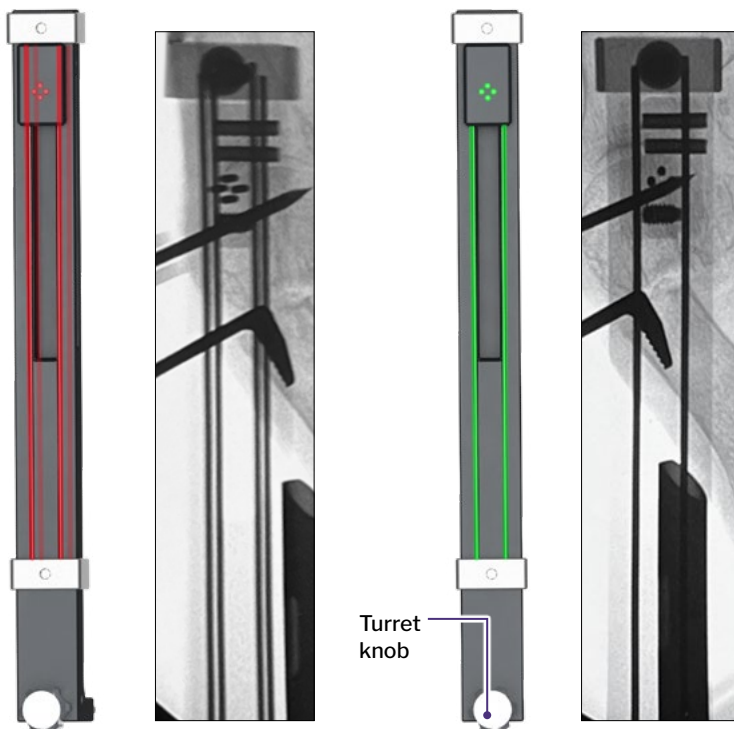

INCORRECT

CORRECT

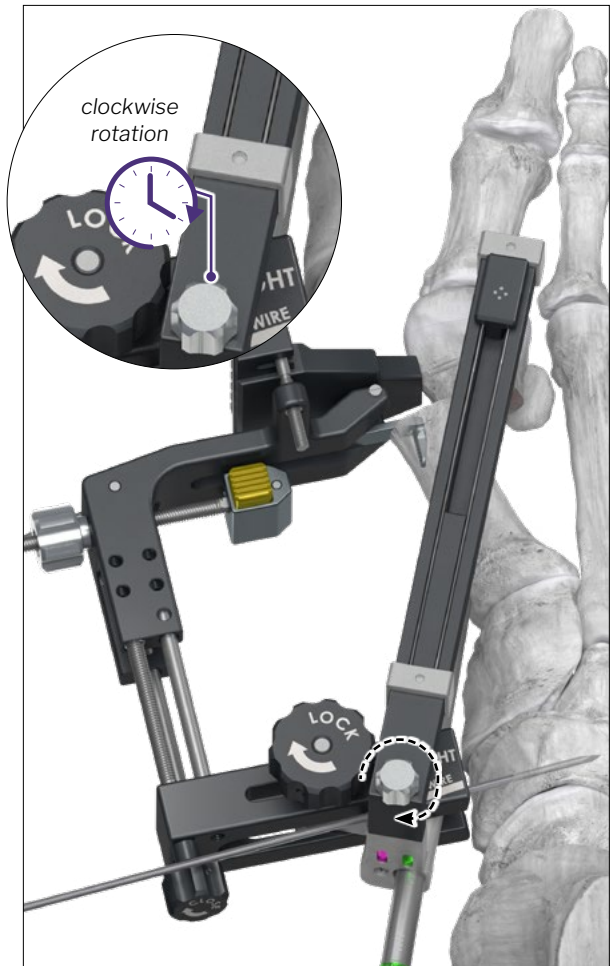

Check that the Outrigger still has proper lateral alignment to the foot, following the guidance on page 8. Once proper positioning is achieved, drive a second Ø2.0 mm K-wire through the remaining hole on the proximal end of the Outrigger into the navicular. If the Outrigger is “floating” (not firmly sitting on the anatomy), the plantar proximal wire can be bent proximally to improve stability.

Remove the Angel Wing and Tissue Protector Tube.

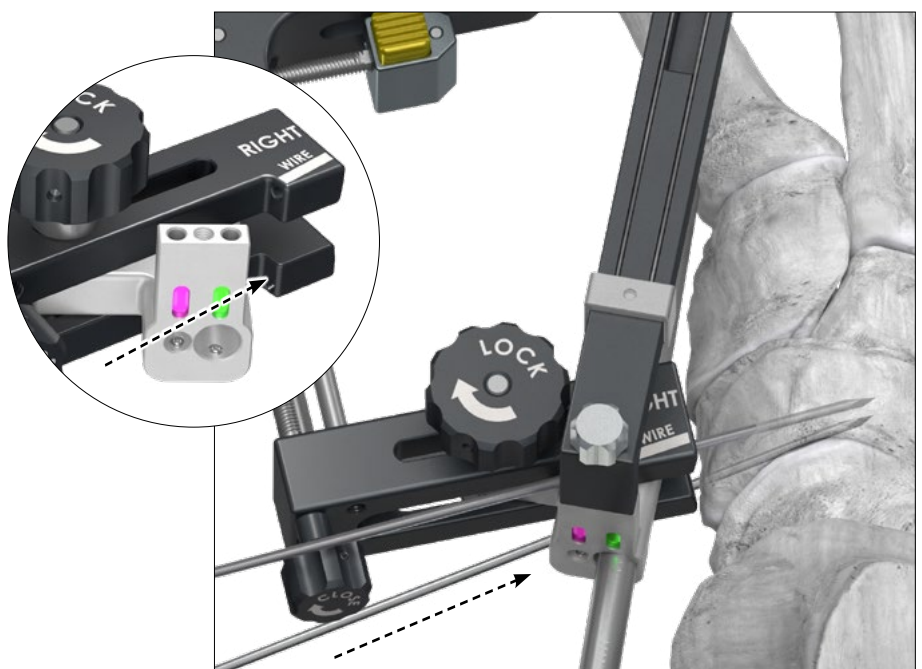

DEFORMITY CORRECTION

1 IM REDUCTION

► Rotate the IM Knob clockwise to translate the 1st metatarsal head laterally until sufficient IM correction is achieved.



NOTE: If too much resistance occurs before ideal translation is achieved: translate as much as possible, then perform the metatarsal head rotation, then attempt to translate further. A piece of gauze can be used to increase grip on the knob as well.

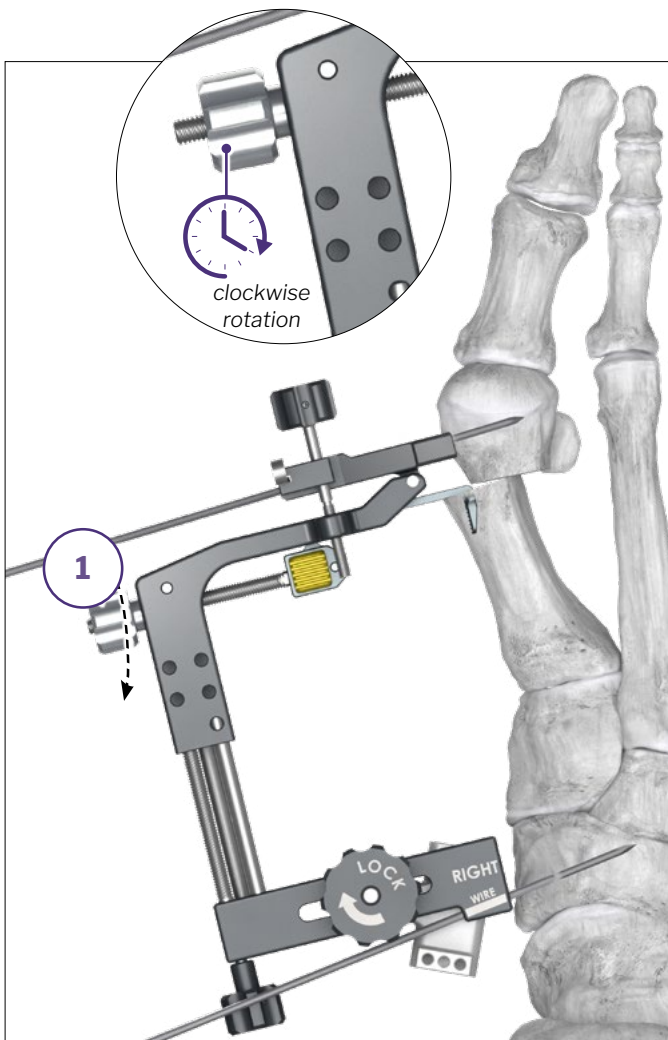

Before

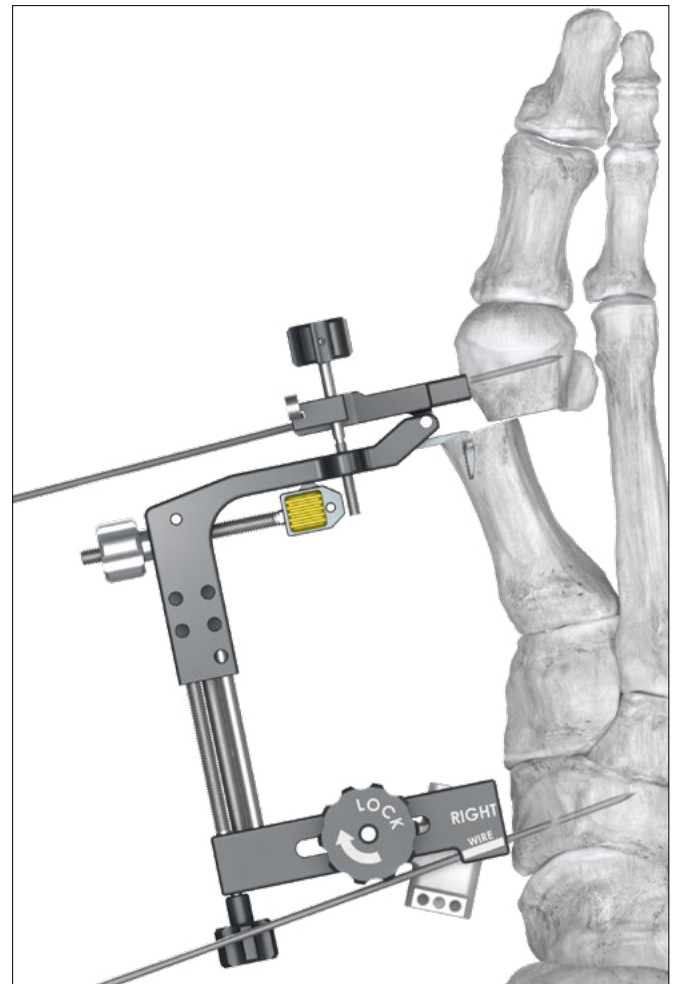

After

DEFORMITY CORRECTION**2 DEROTATION**

- ▶ Open the K-wire Retention Clip on the Rotation Fan. Swivel the distal K-wire dorsally within the Rotation Fan until sufficient derotation is achieved, slotting the K-wire in a track to secure the position. Close the K-wire Retention Clip on the Rotation Fan.

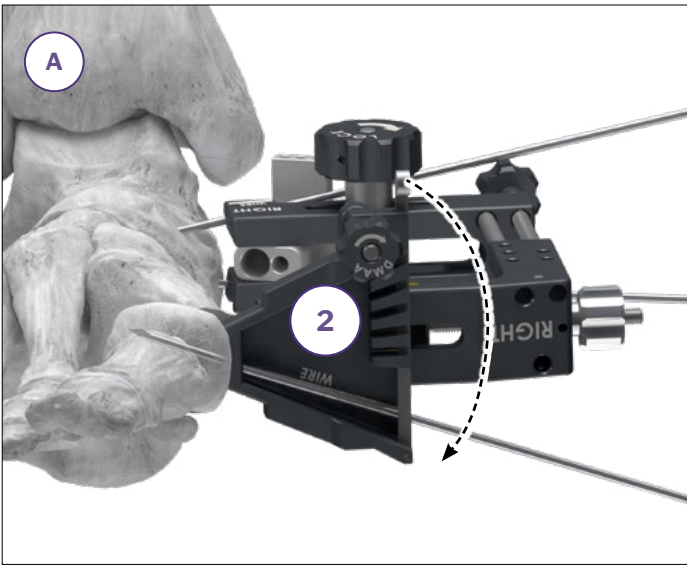

Open Retention Clip



Move wire dorsally to rotate head, set into appropriate notch

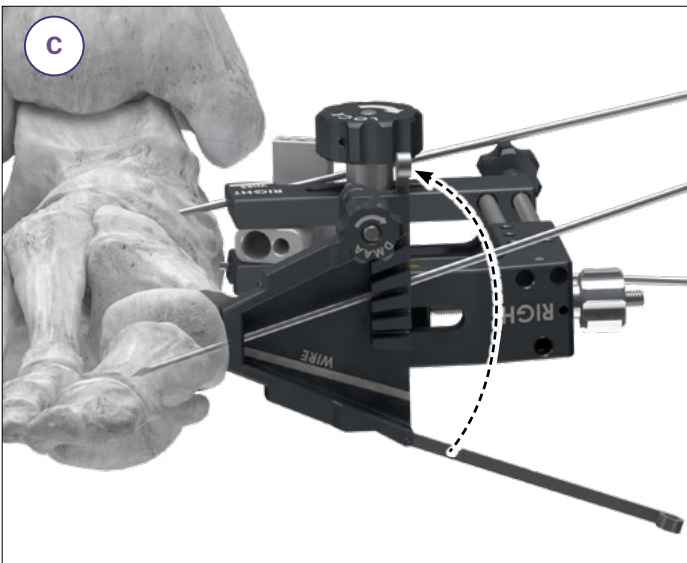

Close Retention Clip



Final Position

DEFORMITY CORRECTION

3 DMAA REDUCTION

► Rotate the DMAA Knob on the Rotation Fan clockwise until sufficient DMAA correction is achieved.

NOTE: Always check for appropriate DMAA correction, even if preoperatively no DMAA deformities were observed.

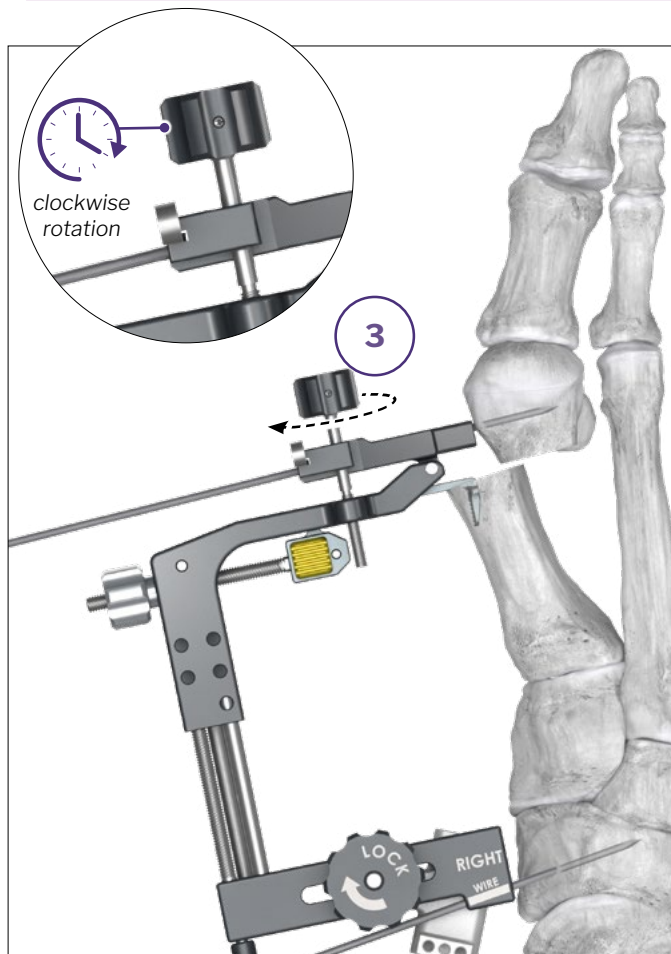

Before

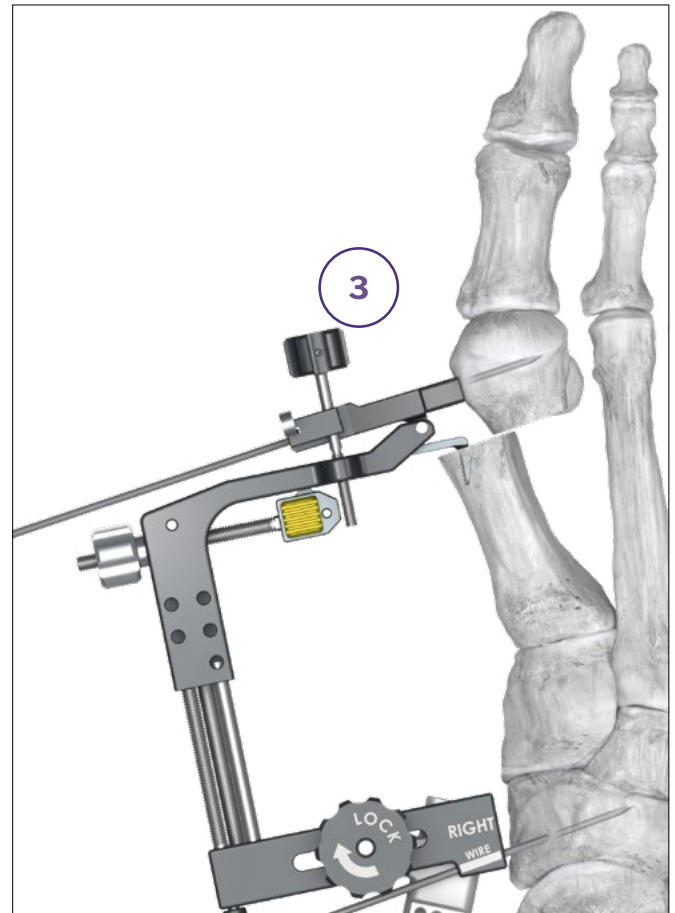

After

NOTE: If sufficient DMAA correction cannot be achieved before the DMAA Knob can no longer be turned clockwise, do the following:

1. Undo any rotation correction previously made
2. Remove the K-wire from the metatarsal head
3. Rotate the DMAA Knob counterclockwise until the Rotation Fan is positioned several degrees greater than parallel to the osteotomy
4. Palpate the metatarsal head to ensure that it is still aligned dorsoplantarily with the metatarsal shaft, then place the Ø2.0 mm K-wire through the Rotation Fan and into the metatarsal head as described on page 13
5. Retry DMAA correction by rotating the DMAA knob clockwise, utilizing the extra travel gained from the readjustments made. Perform the rotation correction again, then continue with the technique as normal

DEFORMITY CORRECTION

4 GAP CLOSURE

- If gapping between the metatarsal head and shaft is observed, hold down the gold Gap Closing button and rotate the Telescoping Knob clockwise until the gap is closed.

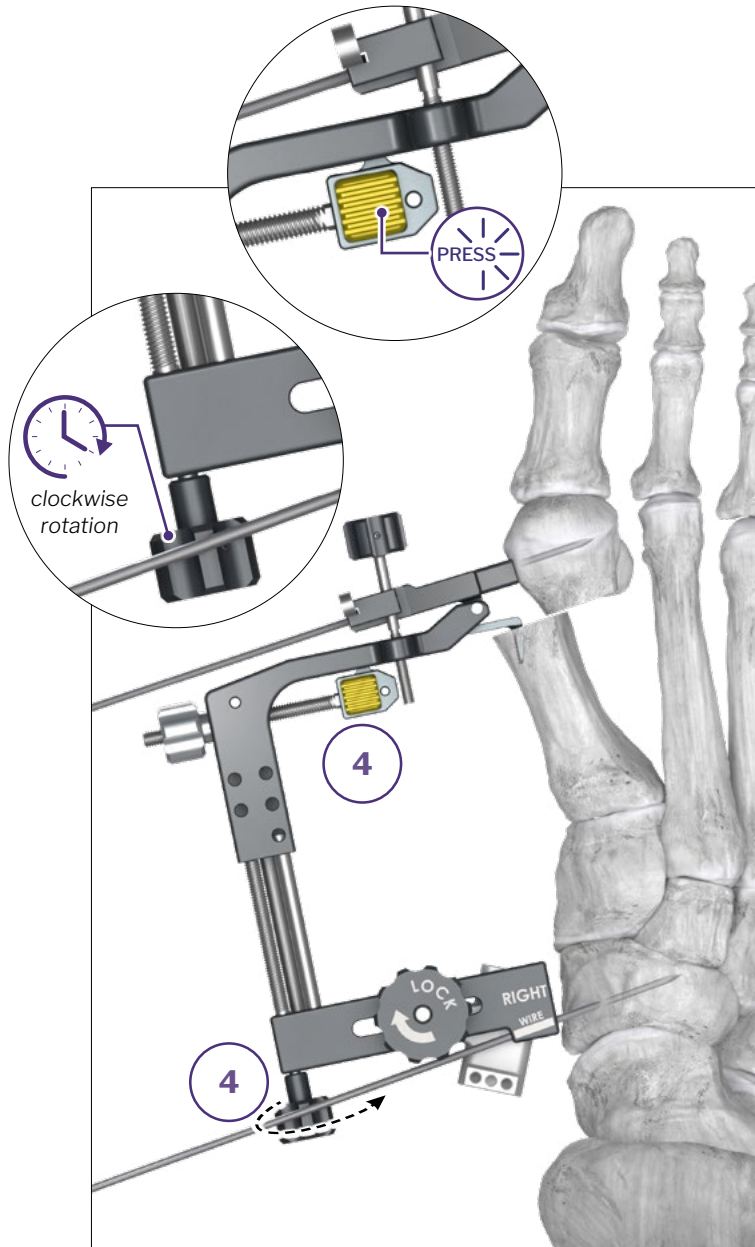

Before

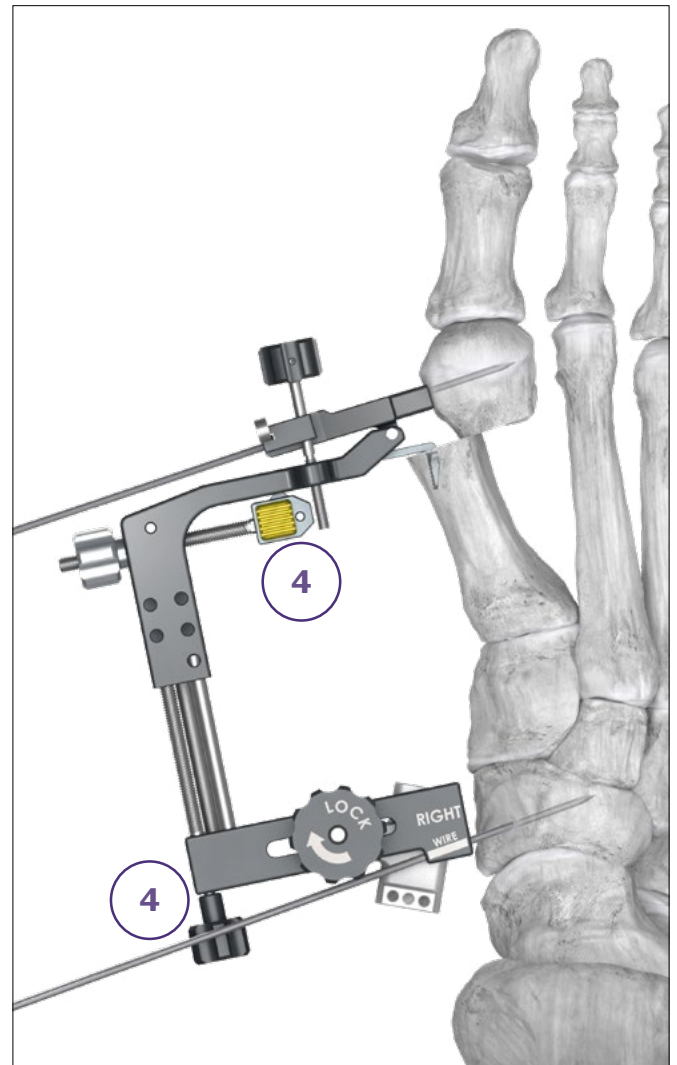

After

CHAMFER SCREW TARGETING

Assemble the Guide Tubes before insertion into the Outrigger as shown below, screwing the smaller tubes into the larger ones with clockwise turns. The Proximal Tube assembly will require the Proximal Screw Tissue Protector Tube.

DISTAL:

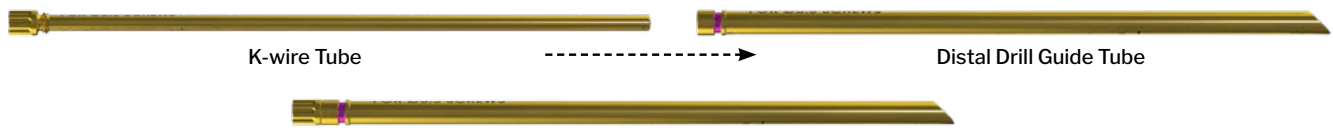

PROXIMAL:

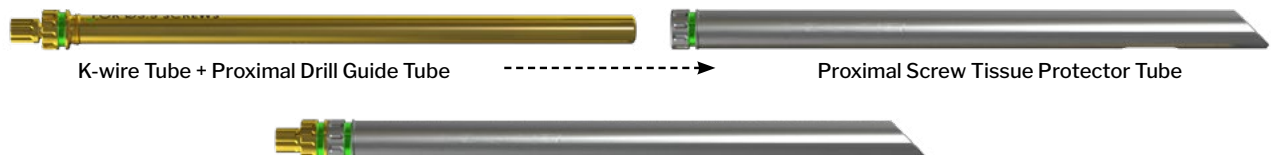
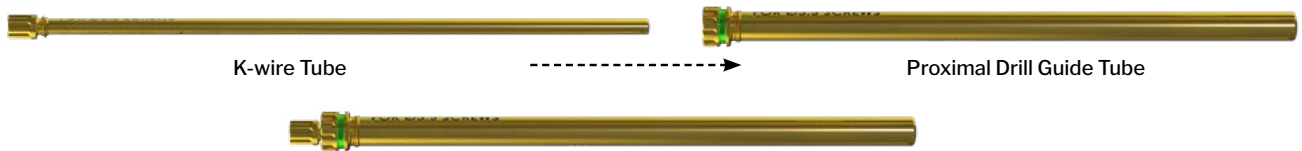

Insert one complete set of Proximal Guide Tubes (Tissue Protector, K-wire, and Drill Tube) into the lateral hole (for the proximal screw) on the proximal end of the Outrigger until the ends touch the skin.

Reattach the Angel Wing and use it to assess the proximal screw trajectory under fluoroscopy.

The Angel Wing wires should be overlaid exactly on top of each other, with the Proximal Wire bisecting the Guide Tubes, and the “clover” should be fully visible. Both the Wire overlay and clover visibility must be confirmed for proper trajectory assessment.

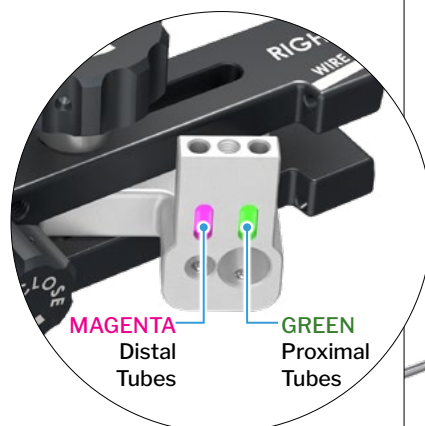
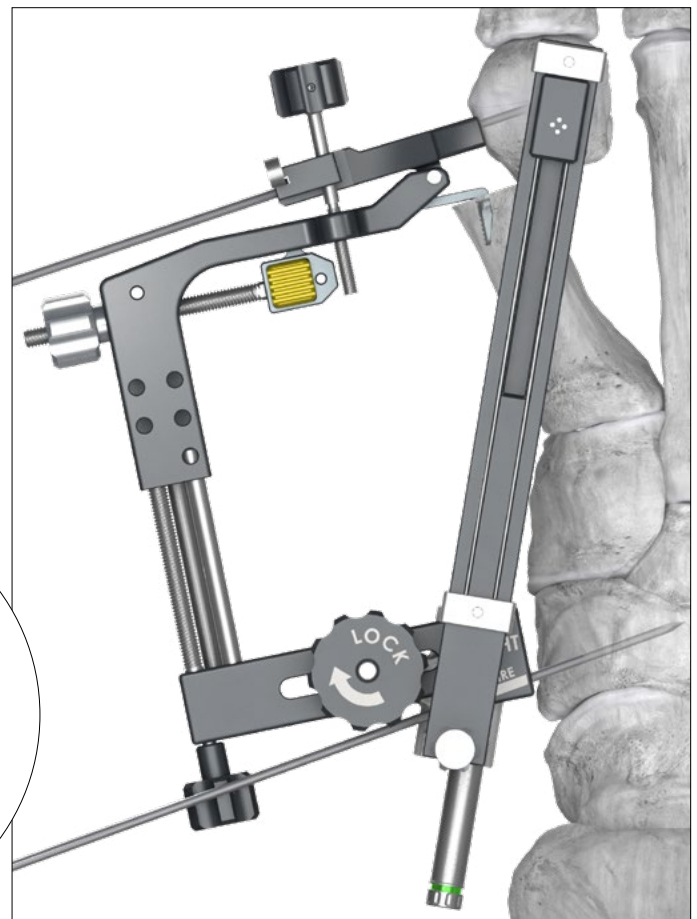

CHAMFER SCREW TARGETING

Unscrew the Trajectory Knob with a counterclockwise turn and adjust the trajectory until ideal.

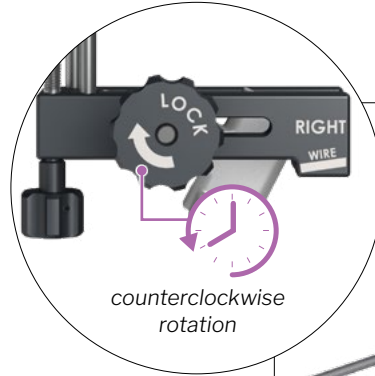

The ideal proximal screw trajectory should:

1. Have good purchase of the lateral cortex of the metatarsal shaft
2. Have good purchase of the metatarsal head
3. Have as proximal of an entry point on the medial wall of the metatarsal shaft as possible.

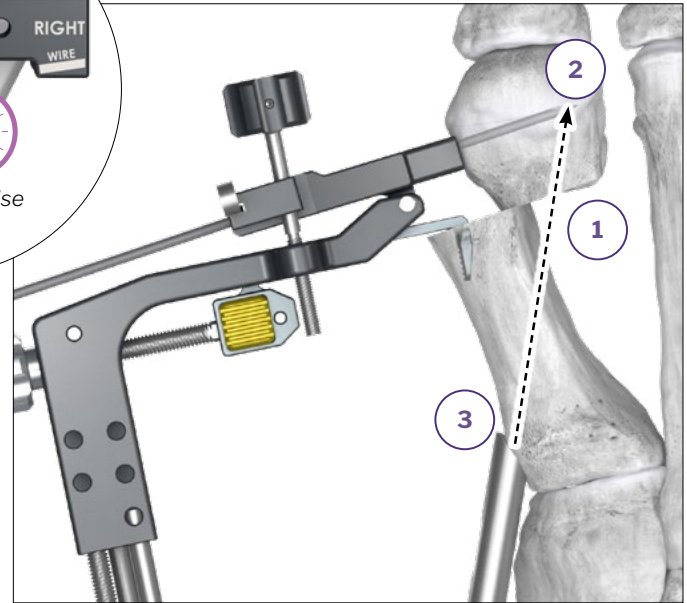

When satisfied with the trajectory, perform a small incision where the Proximal Guide Tubes contact the skin, then perform blunt dissection of the soft tissue through the incision until bone contact with the tube stack is possible.

Reassess the proximal screw trajectory, performing any fine-tune adjustments as needed.

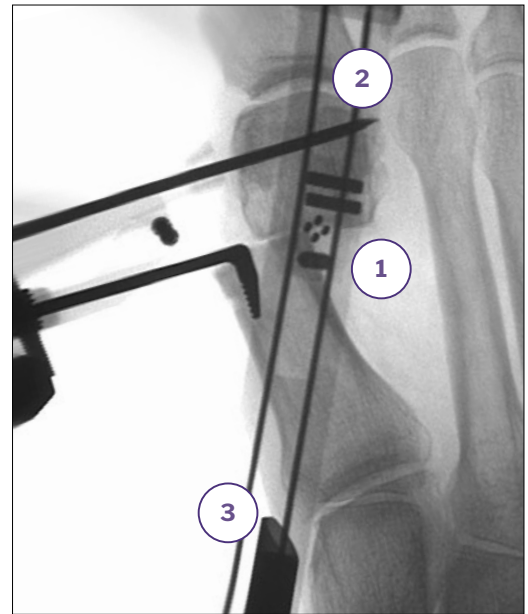

NOTE: The clover portion can be moved along the Angel Wing to improve visualization as needed for different anatomy sizes.



CHAMFER SCREW TARGETING

Once the proper trajectory is achieved, firmly re-tighten the Trajectory Knob with clockwise turns to secure the trajectory.

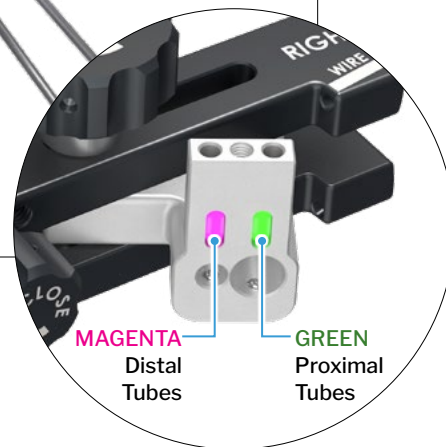
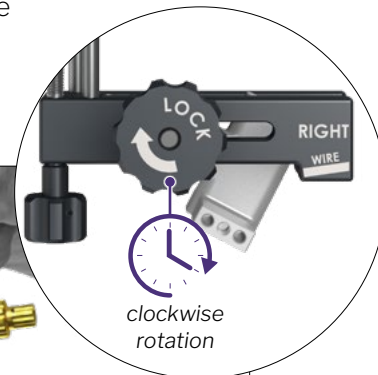

Screw Size:	Ø3.0 mm	Ø3.5 mm	Ø4.0 mm
K-wire Size:	Ø1.2 x 230 mm	Ø1.6 x 230 mm	Ø1.7 x 230 mm
K-wire Tube Size:	Ø3.0 mm	Ø3.5 mm	Ø4.0 mm

While applying slight pressure to the Guide Tubes where they contact the bone and dropping the hand as plantarly as possible, place an appropriately-sized K-wire based on screw size to be used (see table above) through the Proximal Guide Tubes and into the metatarsal fragments, ending in the distal portion of the metatarsal head.

Confirm wire placement and trajectory with fluoroscopy, being sure to check for proper dorsal-plantar trajectory with lateral visualization.

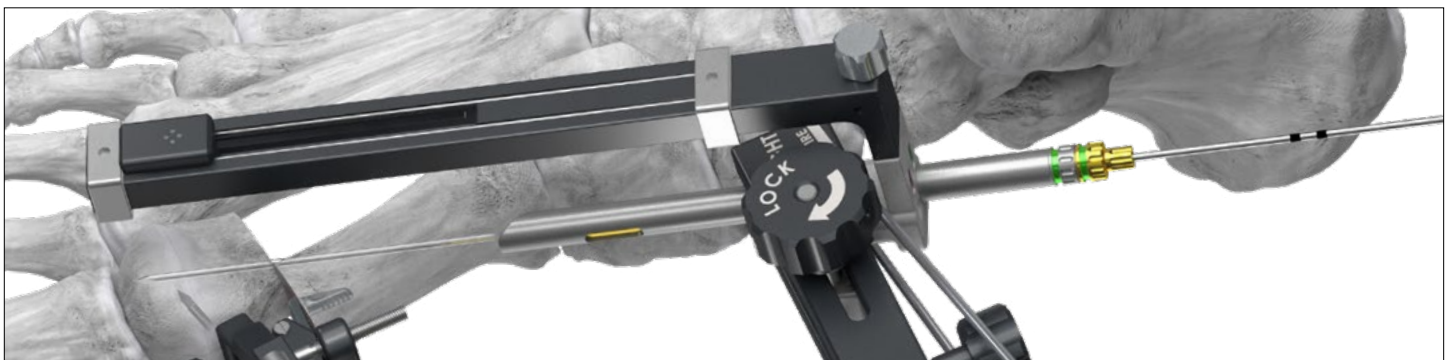

CHAMFER SCREW TARGETING

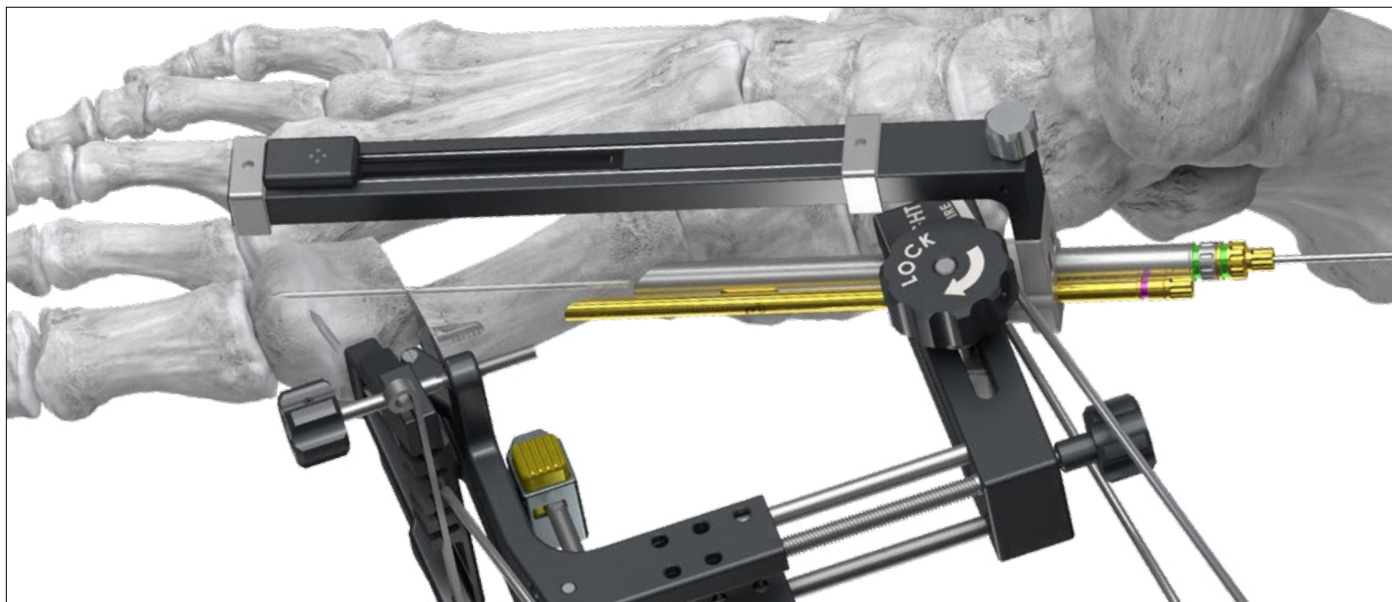

Insert the Distal Guide Tubes (see page 16 for assembly) into the medial hole (for the distal screw) on the proximal end of the Outrigger. Perform small incisions through the skin where the Distal Guide Tubes make contact, then perform blunt dissection of the soft tissue through the incisions until bone contact is possible.



While applying slight pressure to the Guide Tubes where they contact the bone and dropping the hand as plantar as possible, place an appropriately-sized K-wire based on the screw size to be used (see table below) through the Distal Guide Tubes and into the metatarsal fragments, ending in the distal portion of the metatarsal head. Confirm wire placement and trajectory with fluoroscopy.

Screw Size:	Ø3.0 mm	Ø3.5 mm	Ø4.0 mm
K-wire Size:	Ø1.2 x 230 mm	Ø1.6 x 230 mm	Ø1.7 x 230 mm
K-wire Tube Size:	Ø3.0 mm	Ø3.5 mm	Ø4.0 mm

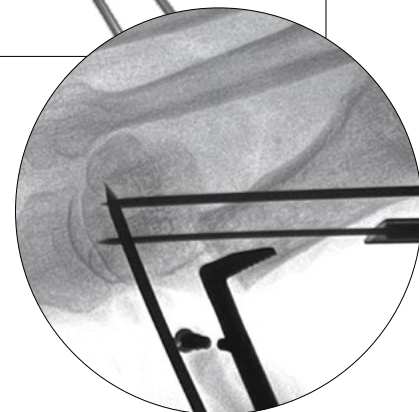

CHAMFER SCREW INSERTION

If the proximal wire contacts or ends within a few millimeters of the perpendicular metatarsal head wire, back out that metatarsal head wire slightly to allow room for drilling.



NOTE: If the medial cortex of the metatarsal is causing the K-wire to skive, the countersink can be used to assist with entry point preparation. Alternatively, the drill can be used to “peck” through the cortex to facilitate wire entry.

If the lateral cortex of the metatarsal is causing the K-wire to skive: under fluoroscopy, drive the proximal wire up to the lateral cortex, leave in place while driving the distal wire, then with the distal wire in place perform the drilling step over the Proximal Wire into the metatarsal head.

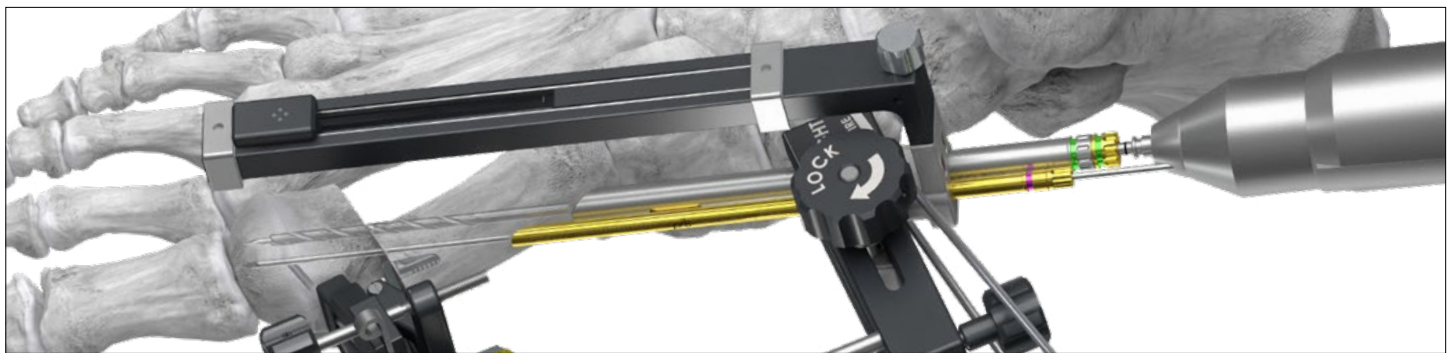
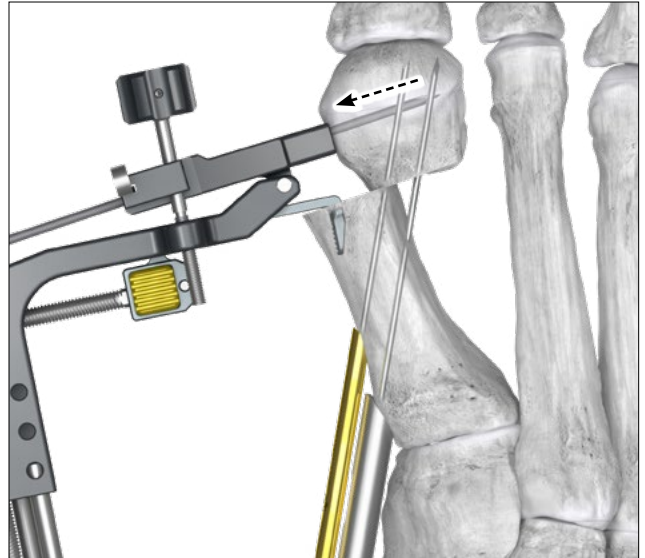

Prepare the Drill that matches the Chamfer Screw diameter to be used (see table). Remove the K-wire Tube from the Proximal Tube set, then drill over the Proximal K-wire into the metatarsal fragments, ending in the distal portion of the metatarsal head. Confirm drilling depth and trajectory with fluoroscopy.

Screw Size:	Ø3.0 mm	Ø3.5 mm	Ø4.0 mm
Drill Size:	Ø2.4 mm	Ø2.7 mm	Ø3.0 mm
Proximal Drill Tube Size:	Ø3.0 mm	Ø3.5 mm	Ø4.0 mm

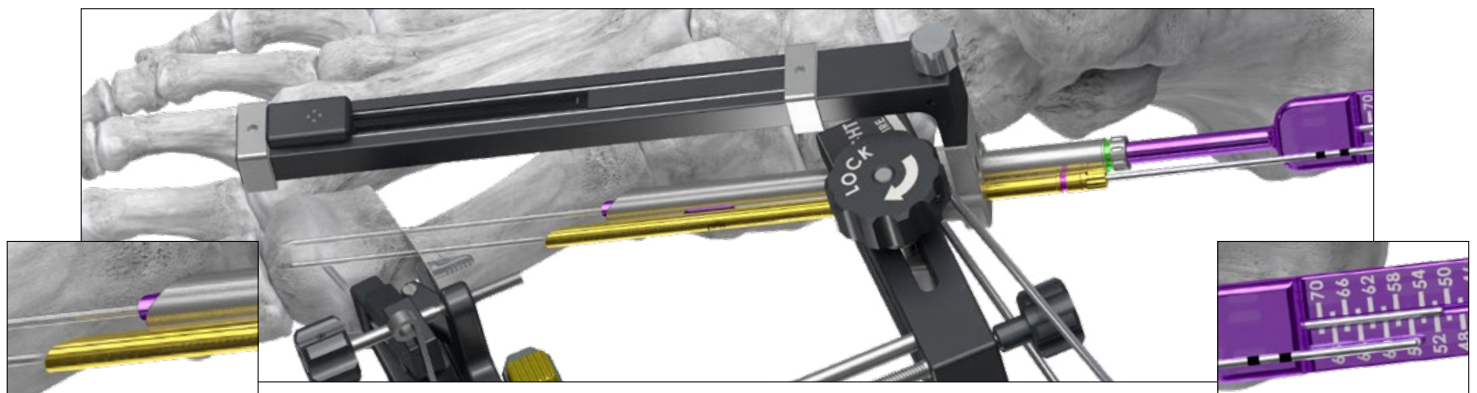

Remove the Drill Guide Tube from the Proximal Tube set, leaving the Tissue Protector Tube in place. Measure for screw length using the depth gauge over the wire, making sure the tip of the gauge touches the bone.

CHAMFER SCREW INSERTION



If desired, use the provided Countersink to help prevent medial cortex fracture in patients with fragile bone, or to improve screw entry in patients with dense bone.



Attach the appropriate Driver for the screw diameter to be used onto the AO Handle. Load the Chamfer Screw onto the Driver so that it is seated securely (see Tip below). Insert the Screw over the Proximal Wire and into the drilled tunnel, advancing it manually or under power. Finish the insertion manually to ensure the chamfer edge is aligned properly with the surface of the bone. Remove the proximal K-wire.



TIP: The Driver uses a modified hexalobe head such that the screw will only load securely in one orientation. The line on the driver indicates the position of the chamfer, as shown above. Rotate the screw on the Driver until it fully seats into the head.

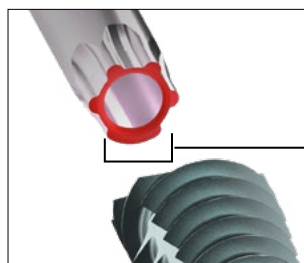

Hexalobe section of Driver tip.

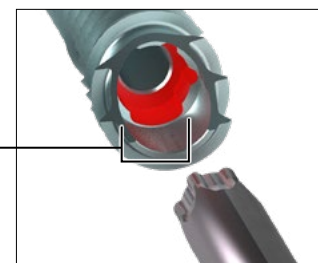

Hexalobe section of Screw head.

CHAMFER SCREW INSERTION



Unscrew and remove the K-wire Guide Tube from the Distal Guide Tube stack. Prepare the Drill that matches the Chamfer Screw diameter to be used, then drill over the Distal K-wire through the guide into the metatarsal fragments, ending in the distal portion of the metatarsal head. Confirm drilling depth and trajectory with fluoroscopy.

Screw Size:	Ø3.0 mm	Ø3.5 mm	Ø4.0 mm
Drill Size:	Ø2.4 mm	Ø2.7 mm	Ø3.0 mm
Drill Guide Size:	Ø3.0 mm	Ø3.5 mm	Ø4.0 mm



TIP: If drilling for the distal screw through the Outrigger is difficult: first, remove the outrigger as described in the next step, then use the “Drill” side of the Handheld Guide to assist in drilling over the distal screw wire.

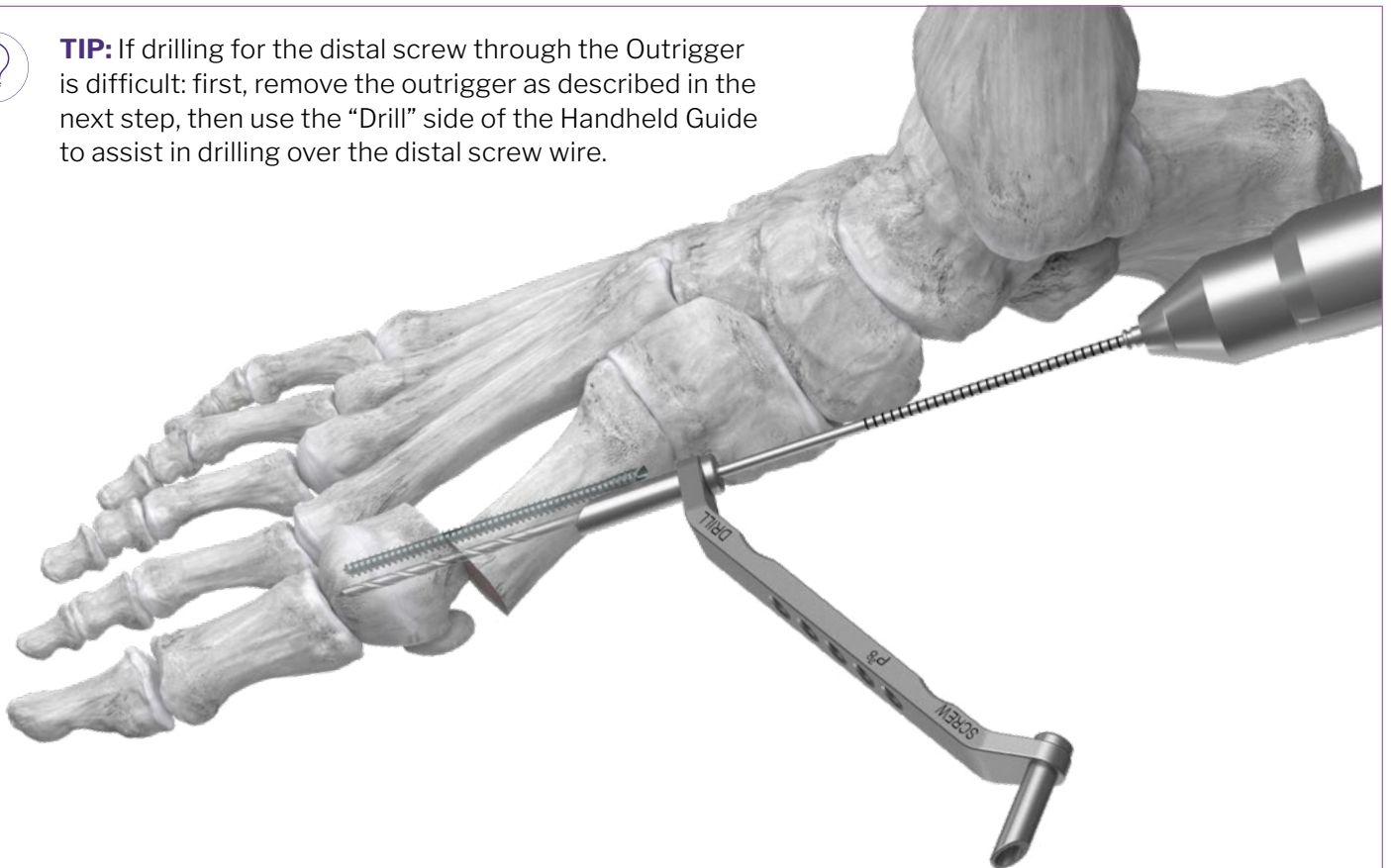

CHAMFER SCREW INSERTION

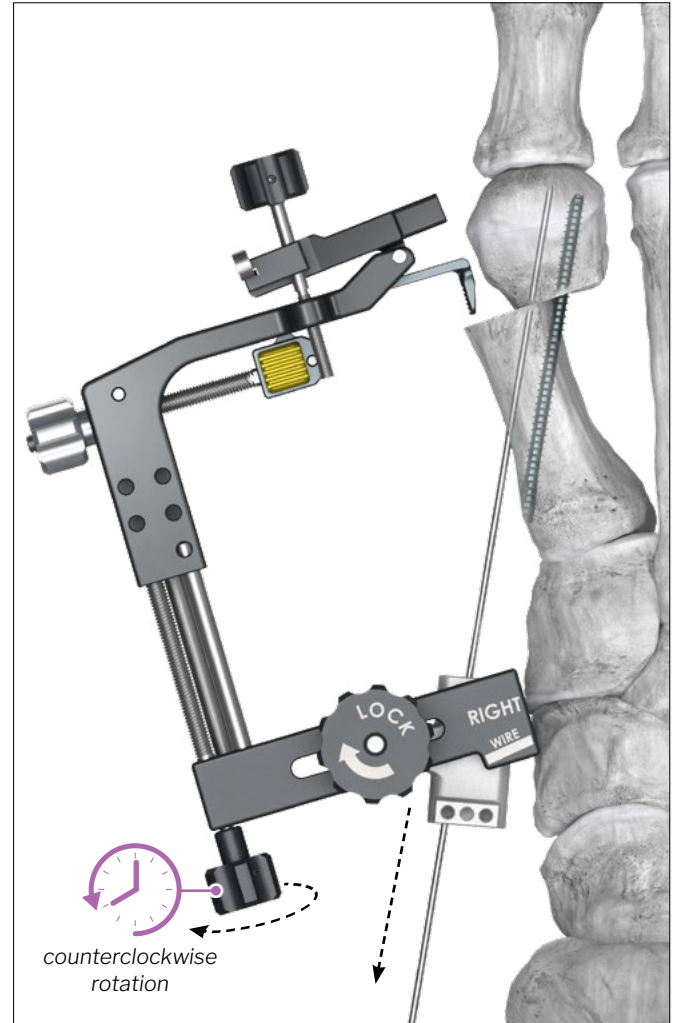
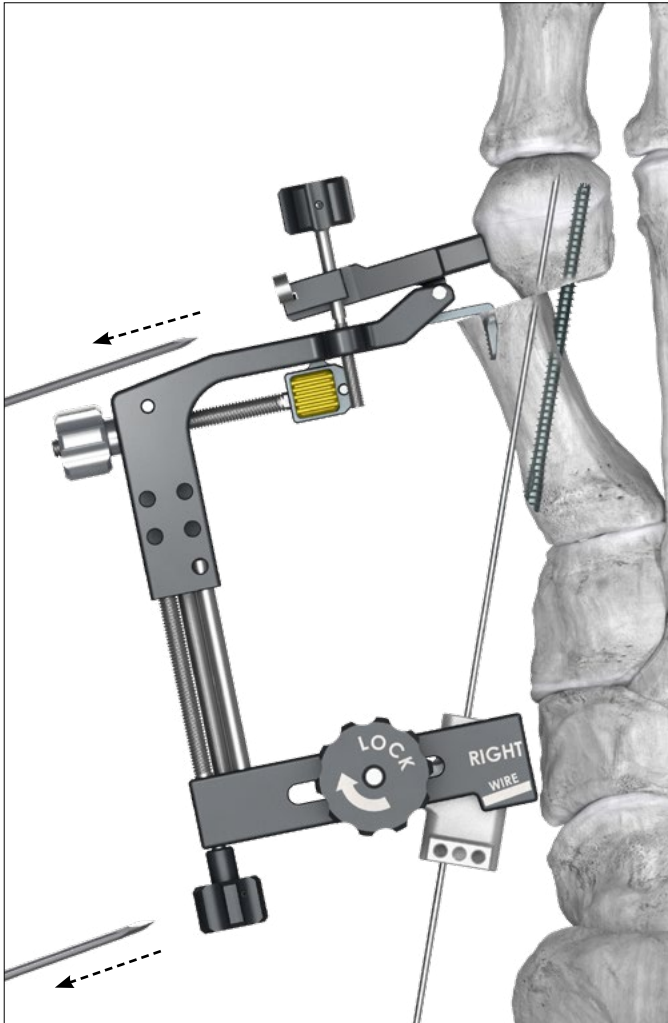

Remove the three K-wires holding the Outrigger onto the foot, then remove the Outrigger from the foot while leaving the distal screw-guiding K-wire in place. The Telescoping Knob can be rotated counterclockwise to provide additional space for hook release, if needed.



Measure for distal screw length using the depth gauge over the wire, making sure the tip of the gauge touches the bone.

CHAMFER SCREW INSERTION

Slide the Handheld Guide over the Distal Wire through the “Screw” side. Attach the appropriate Driver onto the AO Handle. Load the Chamfer Screw onto the Driver so that it is seated securely (see Tip on page 21). Insert the screw over the Distal Wire, through the guide and into the drilled tunnel, advancing it manually or under power.

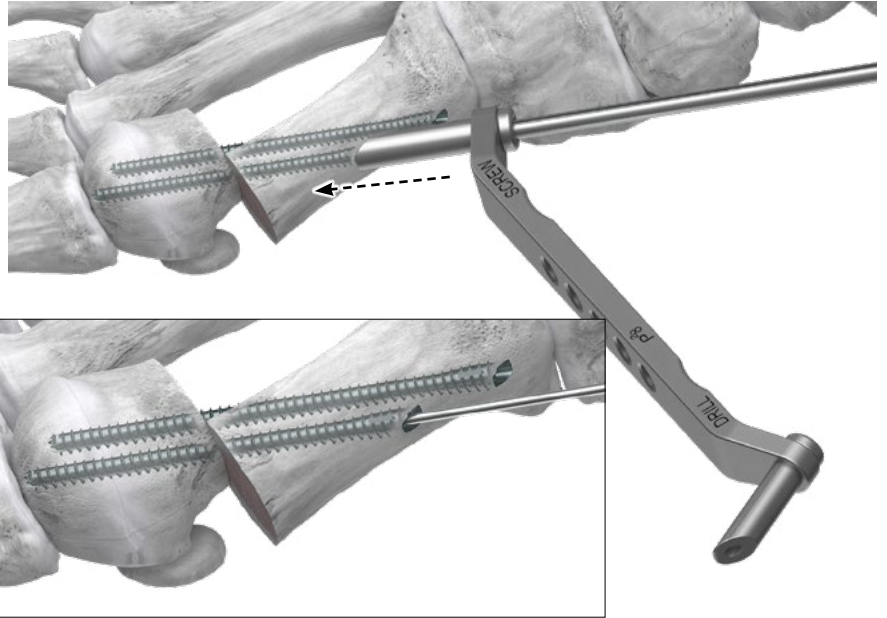

Finish the insertion manually to ensure the chamfer edge is aligned properly with the surface of the bone. Remove the distal K-wire.

CLOSURE

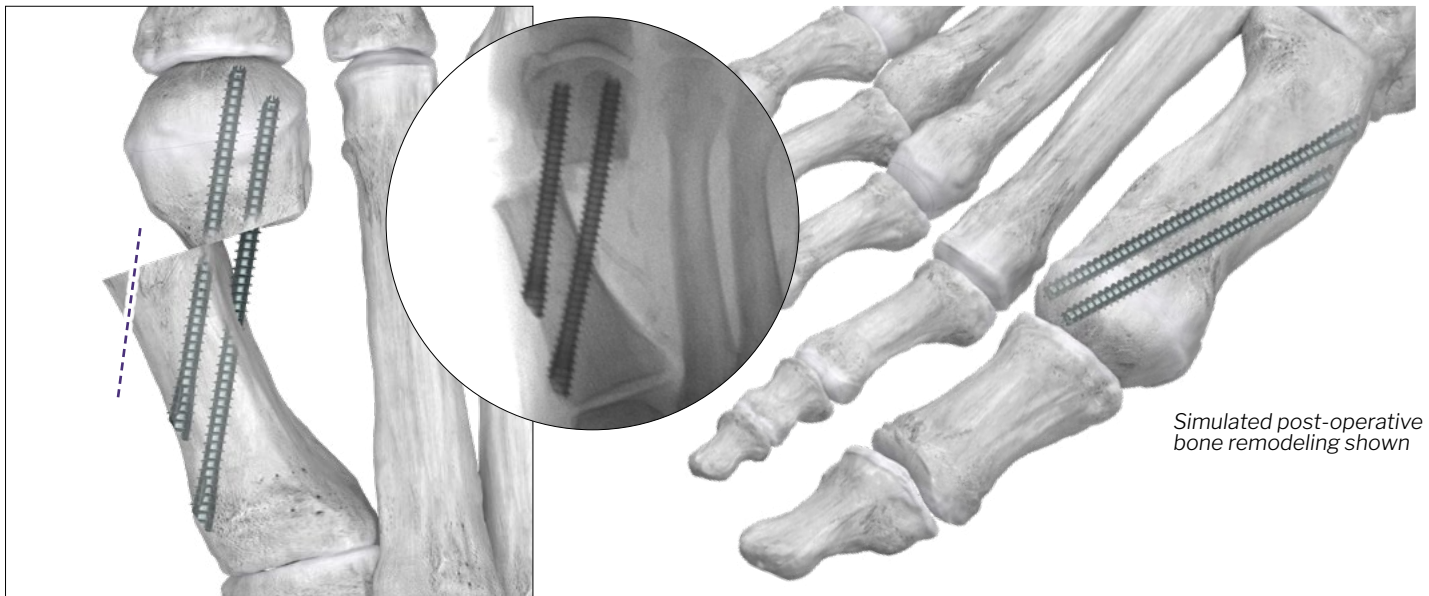

Use a powered burr or other preferred tool to shave down the medial prominence (“step”) of the metatarsal shaft. Proceed to incision closure or concomitant procedures at this time.

REMOVAL

Locate the head of the Chamfer Screw in the proximal end of the metatarsal shaft. Insert a K-wire into the screw cannulation to assist with removal, if desired.

Attach the appropriate driver onto the AO handle; if removing over a K-wire, be sure to use a cannulated driver. Engage the head of the Chamfer Screw with the Driver, rotating until the screw is fully seated (if using the cannulated driver over a wire, see page 21 for tips on driver engagement with the modified hexalobe). Rotate the handle counterclockwise to retreat the screw until it is fully removed from the bone. If two chamfer screws are present, repeat the previous steps to remove the second screw.

The Ø3.0 mm screws can be used for fixation of minimally-invasive Akin osteotomies. The Outrigger device is not used for such an application, therefore instead follow the general technique below:

OSTEOTOMY

Assess and find the incision point for the osteotomy with a blunt object under fluoroscopy (e.g. a freer). The incision point should be at the medial aspect of the 1st proximal phalanx, making sure to avoid the dorsomedial cutaneous nerve. Make the incision, then insert the burr and image with fluoroscopy to confirm correct positioning.

Perform an Akin osteotomy per surgeon preference under fluoroscopy, preserving a lateral cortex hinge to improve stability.



WIRE GUIDE PLACEMENT

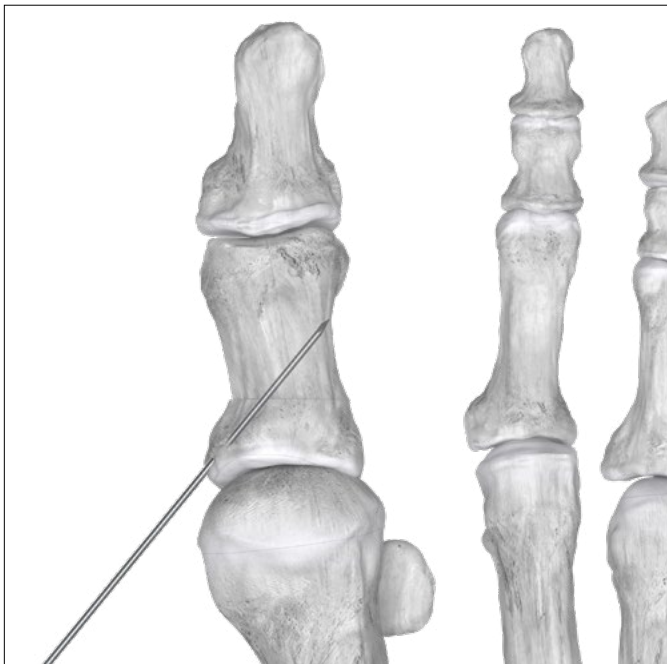

Make a second incision at the base of the proximal phalanx, then hold the phalanx in varus to keep the osteotomy closed and drive a Ø1.2 x 230 mm K-wire distally and laterally through the phalanx and across the osteotomy, ending in the lateral cortex.

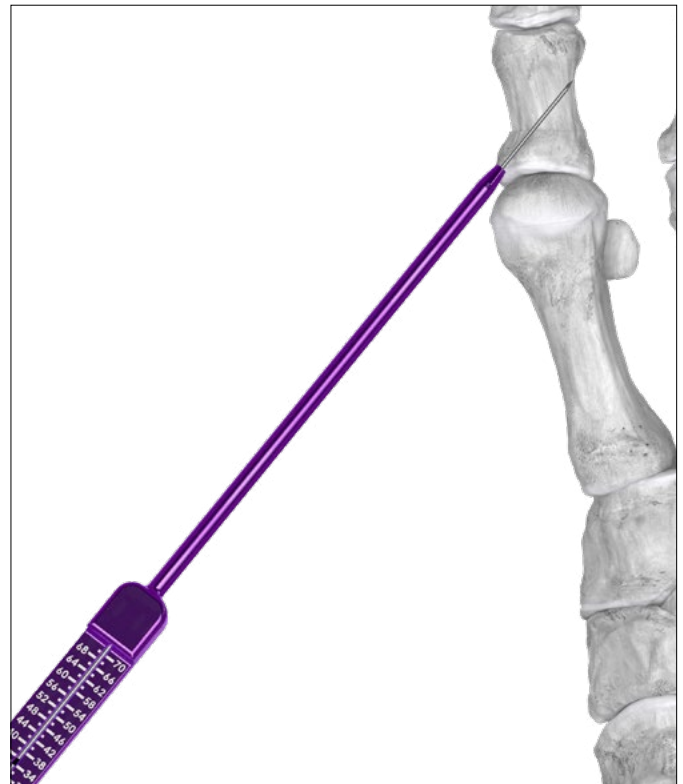

Measure for screw length using the Depth Gauge over the Wire, making sure the tip of the Guide touches the bone.

DRILLING AND SCREW INSERTION



Slide the “Drill” side of the 3.0 mm Handheld Guide over the K-wire, then use the Ø2.40 mm Drill to drill over the K-wire until the lateral cortex is reached.



Remove the Handheld Guide from the K-wire, then slide the “Screw” side of the Handheld Guide back over the K-wire.

Attach the Ø3.0 mm Driver onto the AO Handle. Load the Chamfer Screw onto the Driver so that it is seated securely (see Tip on page 21).

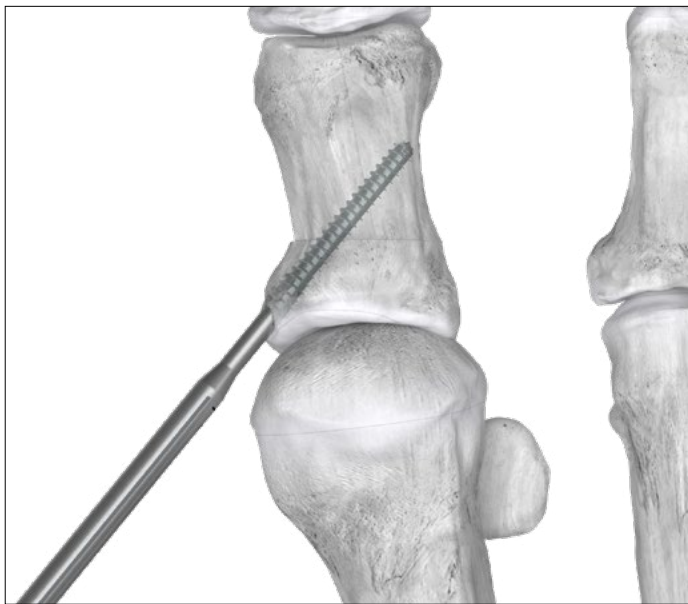

Insert the screw over the K-wire, through the guide and into the drilled tunnel, advancing it manually or under power. Finish the insertion manually to ensure the chamfer edge is aligned properly with the surface of the bone. Remove the K-wire.



Proceed to incision closure or concomitant procedures at this time.

REMOVAL

Refer to page 24 for full removal instructions.

THE PRECISION® MIS BUNION SYSTEM

1. PRECISION® MIS BUNION CASE

The case contains Screw K-wires (Ø1.2 mm, Ø1.6 mm, and Ø1.7 mm), Reduction Wire, Cleaning Wire, Depth Gauge, Drills (Solid and Cannulated), Drivers, Countersinks, Drill Guides, Parallel K-wire Guide, Handles, and Elevators (Curved and Straight).

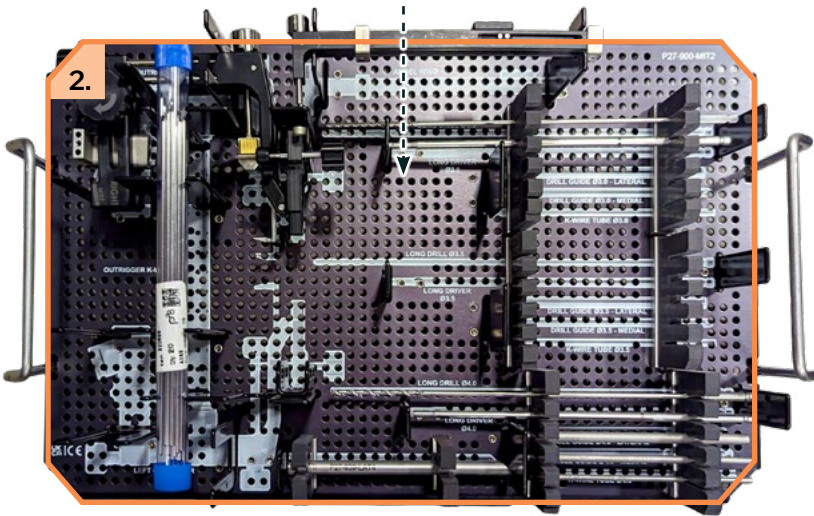
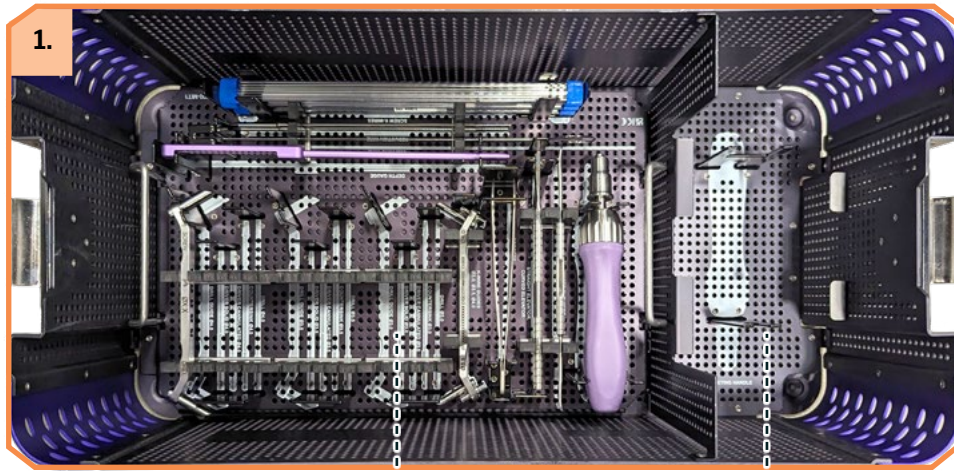

2. PRECISION® MIS BUNION INSTRUMENT TRAY

The tray contains Outrigger K-wires (Ø2.0 mm), Outriggers (Right and Left), Angel Wing, Guide Tubes, Long Drivers, and Long Drills.

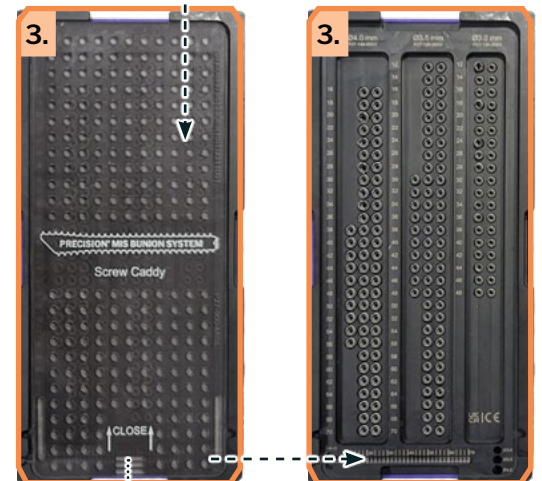

Lid

3. PRECISION® MIS BUNION SCREW CADDY

The caddy contains all Chamfered Screws.

Surgical Technique - Caddy Layout and Contents

CADDY CONTENTS

Part #	Description	Quantity
Ø3.0 Cannulated Screws		
P27-130-0012	Precision MIS Screw, Cannulated, Ø3.0 x 12 mm	2
P27-130-0014	Precision MIS Screw, Cannulated, Ø3.0 x 14 mm	2
P27-130-0016	Precision MIS Screw, Cannulated, Ø3.0 x 16 mm	2
P27-130-0018	Precision MIS Screw, Cannulated, Ø3.0 x 18 mm	2
P27-130-0020	Precision MIS Screw, Cannulated, Ø3.0 x 20 mm	2
P27-130-0022	Precision MIS Screw, Cannulated, Ø3.0 x 22 mm	2
P27-130-0024	Precision MIS Screw, Cannulated, Ø3.0 x 24 mm	2
P27-130-0026	Precision MIS Screw, Cannulated, Ø3.0 x 26 mm	2
P27-130-0028	Precision MIS Screw, Cannulated, Ø3.0 x 28 mm	2
P27-130-0030	Precision MIS Screw, Cannulated, Ø3.0 x 30 mm	2
P27-130-0032	Precision MIS Screw, Cannulated, Ø3.0 x 32 mm	2
P27-130-0034	Precision MIS Screw, Cannulated, Ø3.0 x 34 mm	2
P27-130-0036	Precision MIS Screw, Cannulated, Ø3.0 x 36 mm	2
P27-130-0038	Precision MIS Screw, Cannulated, Ø3.0 x 38 mm	2
P27-130-0040	Precision MIS Screw, Cannulated, Ø3.0 x 40 mm	2
P27-130-0042	Precision MIS Screw, Cannulated, Ø3.0 x 42 mm	2
P27-130-0044	Precision MIS Screw, Cannulated, Ø3.0 x 44 mm	2
P27-130-0046	Precision MIS Screw, Cannulated, Ø3.0 x 46 mm	2
P27-130-0048	Precision MIS Screw, Cannulated, Ø3.0 x 48 mm	2
Ø3.5 Cannulated Screws		
P27-135-0012	Precision MIS Screw, Cannulated, Ø3.5 x 12 mm	2
P27-135-0014	Precision MIS Screw, Cannulated, Ø3.5 x 14 mm	2
P27-135-0016	Precision MIS Screw, Cannulated, Ø3.5 x 16 mm	2
P27-135-0018	Precision MIS Screw, Cannulated, Ø3.5 x 18 mm	2
P27-135-0020	Precision MIS Screw, Cannulated, Ø3.5 x 20 mm	2
P27-135-0022	Precision MIS Screw, Cannulated, Ø3.5 x 22 mm	2
P27-135-0024	Precision MIS Screw, Cannulated, Ø3.5 x 24 mm	2
P27-135-0026	Precision MIS Screw, Cannulated, Ø3.5 x 26 mm	2
P27-135-0028	Precision MIS Screw, Cannulated, Ø3.5 x 28 mm	2
P27-135-0030	Precision MIS Screw, Cannulated, Ø3.5 x 30 mm	2
P27-135-0032	Precision MIS Screw, Cannulated, Ø3.5 x 32 mm	2
P27-135-0034	Precision MIS Screw, Cannulated, Ø3.5 x 34 mm	2
P27-135-0036	Precision MIS Screw, Cannulated, Ø3.5 x 36 mm	2
P27-135-0038	Precision MIS Screw, Cannulated, Ø3.5 x 38 mm	2
P27-135-0040	Precision MIS Screw, Cannulated, Ø3.5 x 40 mm	2
P27-135-0042	Precision MIS Screw, Cannulated, Ø3.5 x 42 mm	2
P27-135-0044	Precision MIS Screw, Cannulated, Ø3.5 x 44 mm	2
P27-135-0046	Precision MIS Screw, Cannulated, Ø3.5 x 46 mm	2

CADDY CONTENTS

P27-135-0048	Precision MIS Screw, Cannulated, Ø3.5 x 48 mm	2
P27-135-0050	Precision MIS Screw, Cannulated, Ø3.5 x 50 mm	2
P27-135-0052	Precision MIS Screw, Cannulated, Ø3.5 x 52 mm	2
P27-135-0054	Precision MIS Screw, Cannulated, Ø3.5 x 54 mm	2
P27-135-0058	Precision MIS Screw, Cannulated, Ø3.5 x 56 mm	2
P27-135-0058	Precision MIS Screw, Cannulated, Ø3.5 x 58 mm	2
P27-135-0060	Precision MIS Screw, Cannulated, Ø3.5 x 60 mm	2
P27-135-0062	Precision MIS Screw, Cannulated, Ø3.5 x 62 mm	2
P27-135-0064	Precision MIS Screw, Cannulated, Ø3.5 x 64 mm	2
P27-135-0066	Precision MIS Screw, Cannulated, Ø3.5 x 66 mm	2
P27-135-0068	Precision MIS Screw, Cannulated, Ø3.5 x 68 mm	2
P27-135-0070	Precision MIS Screw, Cannulated, Ø3.0 x 70 mm	2
Ø4.0 Cannulated Screws		
P27-140-0016	Precision MIS Screw, Cannulated, Ø4.0 x 16 mm	2
P27-140-0018	Precision MIS Screw, Cannulated, Ø4.0 x 18 mm	2
P27-140-0020	Precision MIS Screw, Cannulated, Ø4.0 x 20 mm	2
P27-140-0022	Precision MIS Screw, Cannulated, Ø4.0 x 22 mm	2
P27-140-0024	Precision MIS Screw, Cannulated, Ø4.0 x 24 mm	2
P27-140-0026	Precision MIS Screw, Cannulated, Ø4.0 x 26 mm	2
P27-140-0028	Precision MIS Screw, Cannulated, Ø4.0 x 28 mm	2
P27-140-0030	Precision MIS Screw, Cannulated, Ø4.0 x 30 mm	2
P27-140-0032	Precision MIS Screw, Cannulated, Ø4.0 x 32 mm	2
P27-140-0034	Precision MIS Screw, Cannulated, Ø4.0 x 34 mm	2
P27-140-0036	Precision MIS Screw, Cannulated, Ø4.0 x 36 mm	2
P27-140-0038	Precision MIS Screw, Cannulated, Ø4.0 x 38 mm	2
P27-140-0040	Precision MIS Screw, Cannulated, Ø4.0 x 40 mm	2
P27-140-0042	Precision MIS Screw, Cannulated, Ø4.0 x 42 mm	2
P27-140-0044	Precision MIS Screw, Cannulated, Ø4.0 x 44 mm	2
P27-140-0046	Precision MIS Screw, Cannulated, Ø4.0 x 46 mm	2
P27-140-0048	Precision MIS Screw, Cannulated, Ø4.0 x 48 mm	2
P27-140-0050	Precision MIS Screw, Cannulated, Ø4.0 x 50 mm	2
P27-140-0052	Precision MIS Screw, Cannulated, Ø4.0 x 52 mm	2
P27-140-0054	Precision MIS Screw, Cannulated, Ø4.0 x 54 mm	2
P27-140-0056	Precision MIS Screw, Cannulated, Ø4.0 x 56 mm	2
P27-140-0058	Precision MIS Screw, Cannulated, Ø4.0 x 58 mm	2
P27-140-0060	Precision MIS Screw, Cannulated, Ø4.0 x 60 mm	2
P27-140-0062	Precision MIS Screw, Cannulated, Ø4.0 x 62 mm	2
P27-140-0064	Precision MIS Screw, Cannulated, Ø4.0 x 64 mm	2
P27-140-0066	Precision MIS Screw, Cannulated, Ø4.0 x 66 mm	2
P27-140-0068	Precision MIS Screw, Cannulated, Ø4.0 x 68 mm	2
P27-140-0070	Precision MIS Screw, Cannulated, Ø4.0 x 70 mm	2

Surgical Technique - Caddy Layout and Contents

CADDY CONTENTS

Guided Instrumentation		
P27-110-2420	Ø2.4 mm Cannulated Drill for Ø3.0 Screw, Long	2
P27-110-2720	Ø2.7 mm Cannulated Drill for Ø3.5 Screw, Long	2
P27-110-3020	Ø3.0 mm Cannulated Drill for Ø4.0 Screw, Long	2
P27-190-TL30	Ø3.0 Driver, Cannulated Long	2
P27-190-TL35	Ø3.5 Driver, Cannulated Long	2
P27-190-TL40	Ø4.0 Driver, Cannulated Long	2
P27-192-2015	K-wire, 2.0 mm x 150 mm	16
P31-941-0150	Sterilization Container, K-wire, Outrigger Fixation	1
P27-101-100R	Outrigger, Right	1
P27-101-100L	Outrigger, Left	1
P27-920-ANWG	Angel Wing	1
P27-930-LAT4	Screw Tube, Proximal Screw, Protector	2
P27-931-30LT	Drill Guide Tube, Proximal Screw, 3.0 Drill	2
P27-931-35LT	Drill Guide Tube, Proximal Screw, 3.5 Drill	2
P27-931-40LT	Drill Guide Tube, Proximal Screw, 4.0 Drill	2
P27-931-30MD	Drill Guide Tube, Distal Screw, 3.0 Drill	2
P27-931-35MD	Drill Guide Tube, Distal Screw, 3.5 Drill	2
P27-931-40MD	Drill Guide Tube, Distal Screw, 4.0 Drill	2
P27-932-3000	K-wire Tube, Ø3.0 Screw	4
P27-932-3500	K-wire Tube, Ø3.5 Screw	4
P27-932-4000	K-wire Tube, Ø4.0 Screw	4
Free Hand Instrumentation		
P27-110-2412	Ø2.4 mm Cannulated Drill for Ø3.0 Screw, Short	2
P27-110-2712	Ø2.7 mm Cannulated Drill for Ø3.5 Screw, Short	2
P27-110-3012	Ø3.0 mm Cannulated Drill for Ø4.0 Screw, Short	2
P27-190-TS30	Ø3.0 Driver, Cannulated, Short	2
P27-190-TS35	Ø3.5 Driver, Cannulated, Short	2
P27-190-TS40	Ø4.0 Driver, Cannulated, Short	2
P27-192-3023	Ø1.2 x 230 mm Smooth K-wire for Ø3.0 Screw	8
P27-192-3523	Ø1.6 x 230 mm Smooth K-wire for Ø3.5 Screw	8
P27-192-4023	Ø1.7 x 230 mm Smooth K-wire for Ø4.0 Screw	8
P27-193-3023	Sterilization Container for Ø1.2 x 230 mm K-wire	1
P27-193-3523	Sterilization Container for Ø1.6 x 230 mm K-wire	1
P27-193-4023	Sterilization Container for Ø1.7 x 230 mm K-wire	1
P27-951-3540	Depth Gauge	1
P99-150-0001	Forceps	1
P27-940-0030	Countersink, Ø3.0 Screw	1
P27-940-0035	Countersink, Ø3.5 Screw	1
P27-940-0040	Countersink, Ø4.0 Screw	1

CADDY CONTENTS

P99-150-0160	Freer Elevator	1
P99-150-2703	Straight Elevator	1
P99-150-2704	Curved Elevator	1
P27-943-0030	Drill Guide/Soft Tissue Protector (double sided), Handled, Ø3.0 Screw	1
P27-943-0035	Drill Guide/Soft Tissue Protector (double sided), Handled, Ø3.5 Screw	1
P27-943-0040	Drill Guide/Soft Tissue Protector (double sided), Handled, Ø4.0 Screw	1
P27-999-30CW	Cleaning wire	1
P27-950-3000	Parallel K-wire Guide, Handled, Ø3.0 Screw	1
P27-950-3540	Parallel K-wire Guide, Handled, Ø3.5 and Ø4.0 Screws	1
P27-191-TT30	Ø3.0 Driver, Solid, Short	1
P27-191-TT35	Ø3.5 Driver, Solid, Short	1
P27-191-TT40	Ø4.0 Driver, Solid, Short	1
P27-182-0001	Reduction wire	2
P99-000-AOLG	Handle, AO Connection, Ratcheting	1
Case & Tray Components		
P27-900-MISC	Screw Caddy Base	1
P27-900-MISL	Screw Caddy Lid	1
P27-900-MIT1	Instrument Tray 1	1
P27-900-MIT2	Instrument Tray 2	1
P27-900-MICL	Case Lid	1
P27-900-MICB	Case Base	1

Indications, Contraindications and Warnings

Refer to www.paragon28.com/ifus for the complete and most current instructions for use document.

INDICATIONS FOR USE (MONSTER®)

The Monster® Screw System is indicated for use in bone reconstruction, osteotomy, arthrodesis, joint fusion, ligament fixation, fracture repair and fracture fixation, appropriate for the size of the device. Specific examples include:

Fractures and Osteotomies

- Fractures of the tarsals, metatarsals and other fractures of the foot (i.e. LisFranc)
- Avulsion fractures and fractures of the 5th metatarsal (i.e. Jones Fracture)
- Talar fractures
- Ankle fractures
- Navicular fractures
- Fractures of the fibula, malleolus, and calcaneus
- Metatarsal and phalangeal osteotomies
- Weil osteotomy
- Calcaneal osteotomy

Hallux Valgus Correction

- Fixation of osteotomies (i.e. Akin, Scarf, Chevron)
- Interphalangeal (IP) arthrodesis
- Proximal, midshaft, or distal osteotomy
- Lapidus arthrodesis

Arthrodesis/Deformity Correction

- 1st MTP arthrodesis
- Metatarsal deformity correction
- Tarsometatarsal joint arthrodesis
- Naviculocuneiform joint arthrodesis
- Talonavicular arthrodesis
- Subtalar joint arthrodesis
- Triple arthrodesis
- Medial column arthrodesis
- Subtalar joint distraction arthrodesis
- Ankle arthrodesis
- Lateralizing calcaneal osteotomy
- Lateral column lengthening
- Hammertoe

Fusion resulting from neuropathic osteoarthopathy (Charcot)

such as:

- Medial and lateral column
- Subtalar, talonavicular, and calcaneocuboid

CONTRAINDICATIONS

Use of the Monster® Screw System is contraindicated in cases of inflammation, cases of active or suspected sepsis / infection and osteomyelitis; or in patients with certain metabolic diseases.

All applications that are not defined by the indications are contraindicated. In addition, surgical success can be adversely affected by:

- Acute or chronic infections, local or systemic
- Vascular, muscular or neurological pathologies that compromise the concerned extremity
- All concomitant pathologies that could affect the function of the implant
- Osteopathies with reduced bone substance that could affect the function of the implant
- Any mental or neuromuscular disorder that could result in an unacceptable risk of failure at the time of fixation or complications in post-operative treatment
- Known or suspected sensitivity to metal
- Corpulence; an overweight or corpulent patient can strain the implant to such a degree that stabilization or implant failure can occur
- Whenever the use of the implant comes into conflict with the anatomical structures of physiological status

Other medical or surgical pre-conditions that could compromise the potentially beneficial procedure, such as:

- The presence of tumors
- Congenital abnormalities
- Immunosuppressive pathologies
- Increased sedimentation rates that cannot be explained by other pathologies
- Increased leukocyte (WBC) count
- Pronounced left shift in the differential leukocyte count

Refer to www.paragon28.com/ifus for the complete and most current instructions for use document.

POTENTIAL COMPLICATIONS AND ADVERSE REACTIONS

In any surgical procedure, the potential for complications and adverse reactions exist. The risks and complications with these implants include:

- Loosening, deformation or fracture of the implant
- Acute post-operative wound infections and late infections with possible sepsis
- Migration, subluxation of the implant with resulting reduction in range of movement
- Fractures resulting from unilateral joint loading
- Thrombosis and embolism
- Wound hematoma and delayed wound healing
- Temporary and protracted functional neurological perturbation
- Tissue reactions as the result of allergy or foreign body reaction to dislodged particles.
- Corrosion with localized tissue reaction and pain
- Pain, a feeling of malaise or abnormal sensations due to the implant used
- Bone loss due to stress shielding

All possible complications listed here are not typical of Paragon 28®, Inc. products but are in principle observed with any implant. Promptly inform Paragon 28® as soon as complications occur in connection with the implants or surgical instruments used. In the event of premature failure of an implant in which a causal relationship with its geometry, surface quality or mechanical stability is suspected, please provide Paragon 28® with the explant(s) in a cleaned, disinfected and sterile condition. Paragon 28® cannot accept any other returns of used implants. The surgeon is held liable for complications associated with inadequate asepsis, inadequate preparation of the osseous implant bed in the case of implants, incorrect indication or surgical technique or incorrect patient information and consequent incorrect patient behavior.

WARNINGS AND PRECAUTIONS

- Re-operation to remove or replace implants may be required at any time due to medical reasons or device failure. If corrective action is not taken, complications may occur.
- Use of an undersized screw in areas of high functional stresses may lead to implant fracture and failure.
- Plates and screws, wires, or other appliances of dissimilar metals should not be used together in or near the implant site.
- The implants and guide wires are intended for single use only. Re-use may cause product failure and could lead to disease transmission.
- Instruments, guide wires and screws are to be treated as sharps.
- Do not use other manufacturer's instruments or implants in conjunction with the Monster® Screw System.

MR SAFETY INFORMATION

The Monster® Screw System has not been evaluated for safety and compatibility in the MR environment. It has not been tested for heating, migration, or image artifact in the MR environment. The safety of the Monster® Screw System in the MR environment is unknown. Scanning a patient who has this device may result in patient injury.

PRECISION[®] MIS BUNION SYSTEM

SURGICAL TECHNIQUE GUIDE

Precision[®] MIS Bunion System

P27-STG-0001 Rev A [2024-01-26]

[™]Trademarks and [®]Registered Marks of Paragon 28[®], Inc.
© Copyright 2024 Paragon 28[®], Inc. All rights reserved.
Patents: www.paragon28.com/patents

Paragon 28[®], Inc.
14445 Grasslands Dr.
Englewood, CO 80112 USA
(855) 786-2828 🇺🇸

Exclusively foot & ankle
Paragon[®] 28
www.Paragon28.com

Disclaimer:

The purpose of the Precision[®] MIS Bunion System Technique Guide is to demonstrate the optionality and functionality of the Precision[®] MIS Bunion System implants and instrumentation. CAUTION: Federal Law (USA) restricts this device to sale and use by, or on the order of, a physician.